

**Manitex**



**TC500**

**50-ton (45 mt) TELESCOPIC CRANE**  
**TC500 SERIES PRODUCT GUIDE**

# CONTENTS

Crane Features .....	4
5096S Chassis Data - S Models .....	5
50110S & SHL Chassis Data .....	6
50128S & SHL Chassis Data .....	7
50155S & SHL Chassis Data .....	8
Outrigger Extension.....	9
5096S Load Chart: Main Boom.....	10
5096S Boom Diagram & Jib Loading Capacities.....	11
50110S Load Chart: Main Boom.....	12
50110S Boom Diagram & Jib Loading Capacities.....	13
50110SHL Load Chart: Main Boom.....	14
50110SHL Boom Diagram & Jib Loading Capacities .....	15
50128S Load Chart: Main Boom.....	16
50128S Boom Diagram & Jib Loading Capacities.....	17
50128SHL Load Chart: Main Boom.....	18
50128SHL Boom Diagram & Jib Loading Capacities .....	19
50155S Load Chart: Main Boom.....	20
50155S Boom Diagram & Jib Loading Capacities.....	21
50155SHL Load Chart: Main Boom.....	22
50155SHL Boom Diagram & Jib Loading Capacities .....	23
Area of Operation .....	24
LMI Codes .....	24
Reeving Diagram .....	24
Technical Descriptions .....	25
Options.....	26 & 27

Effective Date: September 1, 2013

This document is non-contractual. This document is supplied for reference use only. We are constantly making improvements to our products and reserve the right that specification, equipment, and prices are all subject to change without notice or obligation.

The photographs, and /or images in this document are for illustrative purposes only and may include optional equipment and accessories and may not include all standard equipment.

Refer to the appropriate Operator's Manual and Load Charts for instructions on the proper use of this equipment to determine allowable crane lifting capacities, assembly and operating procedures.

Failure to follow the appropriate operator's manual or load chart(s) when using our equipment or to otherwise act irresponsibly may result in serious injury or death.

The only warranty applicable to our equipment is the standard written warranty applicable to the particular product and sale. Manitex makes no other warranty, expressed or implied.



















Products and services listed may be trademarks, service marks or trade-names of Manitex International and /or its subsidiaries in the USA and other countries.

















All rights are reserved. Manitex® is a registered trademark of Manitex International, Inc. in the USA and many other countries.

Copyright 2013 Manitex Inc. Manitex Inc, Georgetown Texas, 78626



# KEY

	Operator aids
	Cab
	Heating / Air conditioning
	Controls
	Hoist speed
	1 - Main hoist 2 - Auxiliary winch 3 - Recovery winch
	Rope length
	Rope - Standard/optional
	Rope diameter
	Permissible line pull
	Maximum line pull
	Slewing / Allowable slewing range
	Slewing gears
	Slewing brake
	Outriggers / Lifting on outriggers
	2-Person man basket
	Counterweight
	Radio remote control

	Hook block
	Distance from hook to head sheave pin
	Hook and ball
	Hydraulics
	Boom elevation angle
	Max. boom length with extension
	Boom with extension retracted
	Boom angle
	Telescoping mode
	Working radius
	Boom length
	Hydraulic actuated boom
	Full power mechanical synchronized
	Boom head / Hook block dimension
	Main boom with auxiliary head
	Tip height



## THE TC500 SERIES TELESCOPIC CRANE

Versatile. Affordable. User friendly.

The TC500 series telescopic cranes are built to meet the wide-ranging needs of owner operators who may use it for residential construction one day and bridge work the next. No matter what the task, the 50-ton line of telescopic cranes is designed to get you to the job and on the job quickly.

With it, you can:

- Go from Free-Swing to No-Free Swing with a flip of a switch.
- Set up quickly with radio outrigger controls
- Operate comfortably and confidently in its tiltable cab

### Other features include:

- 50-ton capacity @ 6 ft. radius
- 4 & 5-section proportional boom
- Optional telescopic jib
- 187 ft. maximum tip height (with optional telescopic jib)
- Tiltable cab
- Out-and-down outriggers
- Remote outrigger controls

### RADIO OUTRIGGER CONTROLS

Operate the outriggers remotely, with a clear view of the machine, using radio outrigger controls we call ROC Solid.

### TWO-SPEED PLANETARY HOIST

Increase productivity and minimize downtime. The two-speed planetary hoist lets you change line speed on the fly and minimize rope stacking.

### REMOTE WINCH CONTROL

Lower and raise the hook block quickly. With remote winch control on the TC500 series, the winch can be operated from any location. (OPTIONAL)



Operator cab tilts from 0° to 20° for a comfortable, clear view of the load.

### INCREASE PROFITABILITY

The versatile TC500 series is designed to help both owners and operators make the most of their investment.

- Travel to and between jobs at highway speed.
- Minimize maintenance costs with replaceable, self-lubricating boom slider pads and sealed, multi-disc wet brakes on the hoist and swing system.
- Minimize repair costs with first-up auto retract feature of front bumper stabilizer that prevents drive-away damage.



# 5096S CHASSIS DATA

## Dimensions

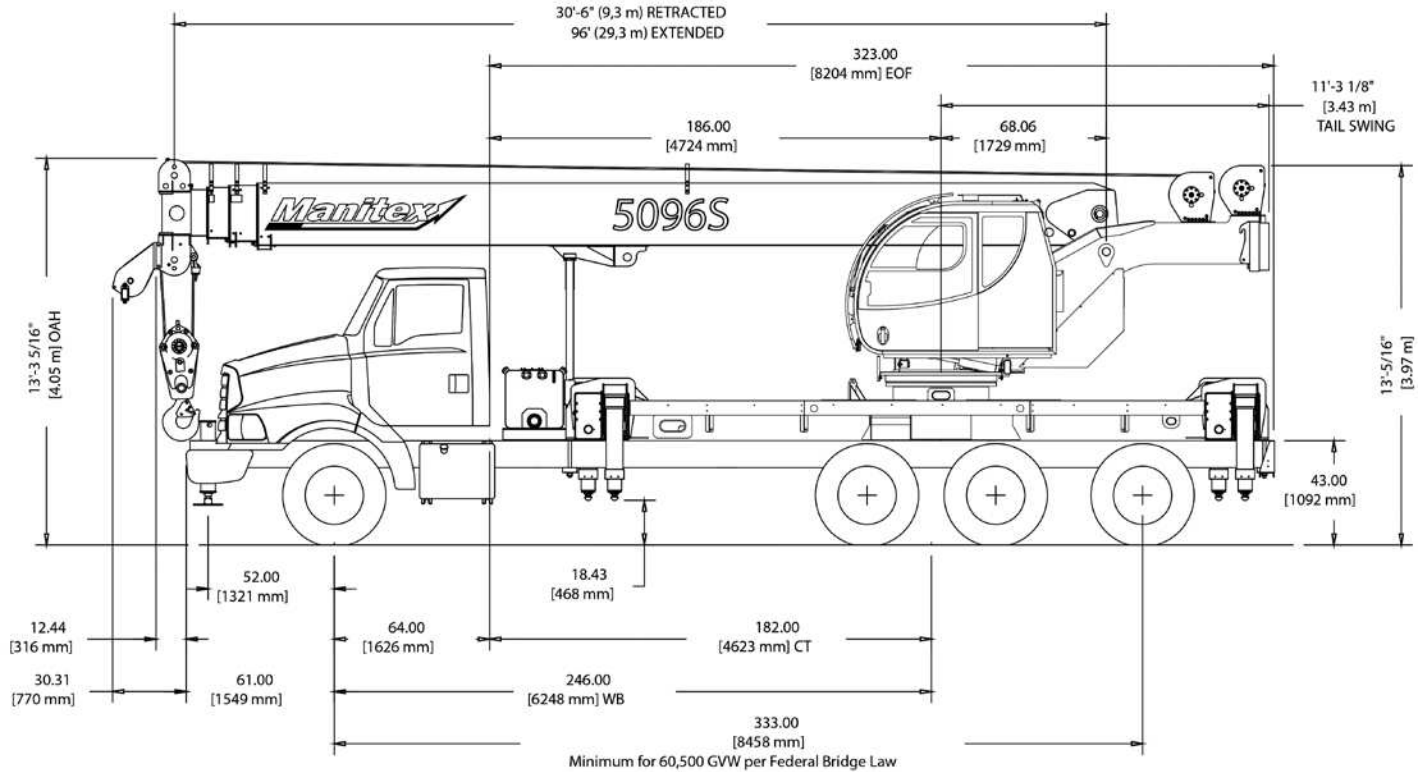

## Auxiliary Sheave Head

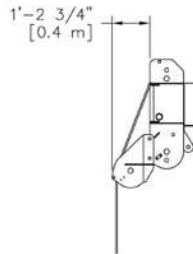

## CHASSIS DATA

Model	5096S
Frame section modulus at 180/360° area of operation*	27.0 in <sup>3</sup> 120,000 psi 827,371 kPa

\* Frame selection modulus at 360° area of operation requires front bumper stabilizer.

## CRANE WEIGHT

	5096S
Crane	35,755 lbs. (16,218 kg)
Jib fixed	1,510 lbs. (685 kg)
Jib telescopic	1,870 lbs. (848 kg)
Aluminum Platform	621 lbs. (282 kg)

## TRUCK AXLE WEIGHT

	5096S
Min. truck axle W - Front**	9,100 lbs. (4,127 kg)
Min. truck axle W - Rear**	11,150 lbs. (5,057 kg)
Nominal Frame W	34 in. (864 mm)

\*\* Minimum chassis weight is required to meet 85% stability requirements. Chassis data is general - not for engineering. Some dimensions depend on truck selection.

Notes: Additional axles required for federal bridge legal configuration - consult Manitex. Manitex highly recommends the addition of a front stabilizer and it may be required on some installations - consult Manitex.

Data published herein is intended as a guide only. Crane operation is subject to machine specific load charts and information.

# 50110S & SHL CHASSIS DATA

## Dimensions

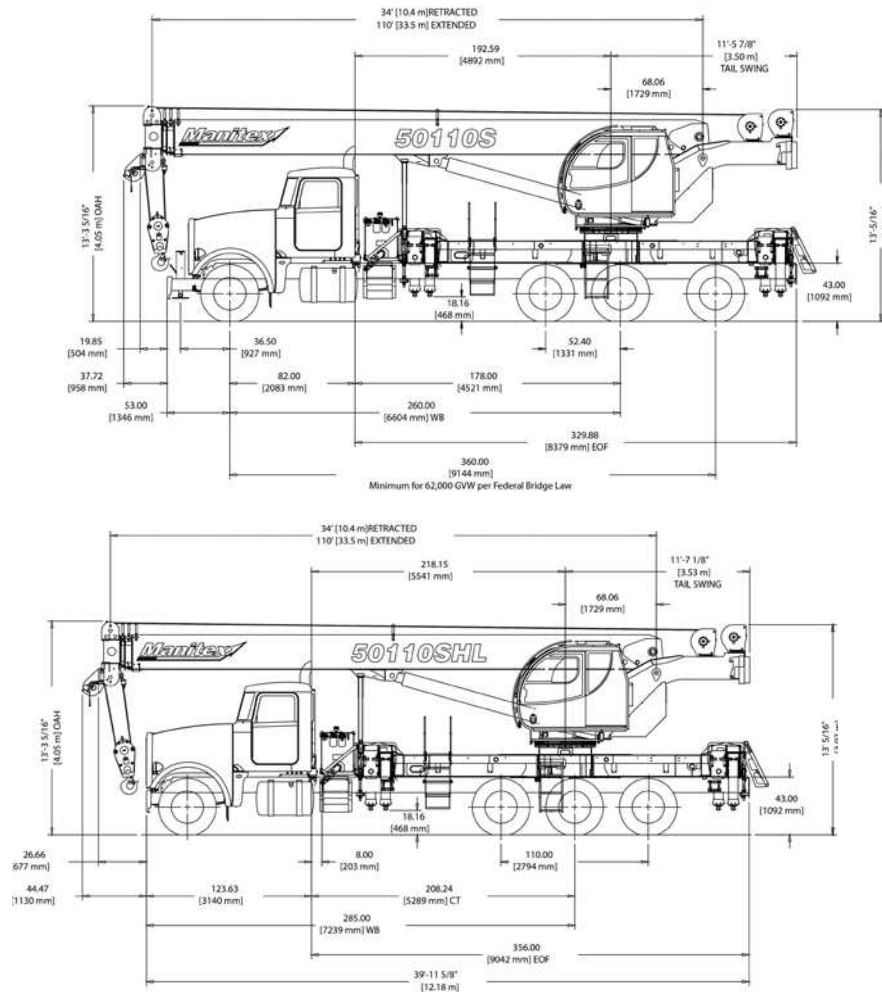

## Auxiliary Sheave Head

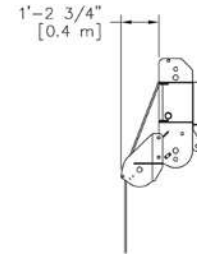

## CHASSIS DATA

Model	50110S	50110SHL
Frame section modulus at 180/360° area of operation*	27.0 in <sup>3</sup> 120,000 psi, 827,371 kPa	27.0 in <sup>3</sup> 120,000 psi, 827,371 kPa

\* Frame selection modulus at 360° area of operation requires front bumper stabilizer.

## TRUCK AXLE WEIGHT

Model	50110S	50110SHL
Min. truck axle W - Front**	9,000 lbs. (4,173 kg)	10,700 lbs. (4,853 kg)
Min. truck axle W - Rear**	10,600 lbs. (4,808 kg)	15,200 lbs. (6,894 kg)
Nominal Frame W	34 in. (864 mm)	34 in. (864 mm)

\*\* Minimum chassis weight is required to meet 85% stability requirements. Chassis data is general - not for engineering. Some dimensions depend on truck selection.

## CRANE WEIGHT

Model	50110S	50110SHL
Crane	37,422 lbs. (16,974 kg)	43,846 lbs. (19,888 kg)
Jib fixed	1,510 lbs. (685 kg)	1,510 lbs. (685 kg)
Jib telescopic	1,870 lbs. (848 kg)	1,870 lbs. (848 kg)
Aluminum Platforms	621 lbs. (282 kg)	621 lbs. (282 kg)

Notes: Additional axles required for federal bridge legal configuration - consult Manitex. Manitex highly recommends the addition of a front stabilizer and it may be required on some installations - consult Manitex.

Data published herein is intended as a guide only. Crane operation is subject to machine specific load charts and information.

# 50128S & SHL CHASSIS DATA

## Dimensions

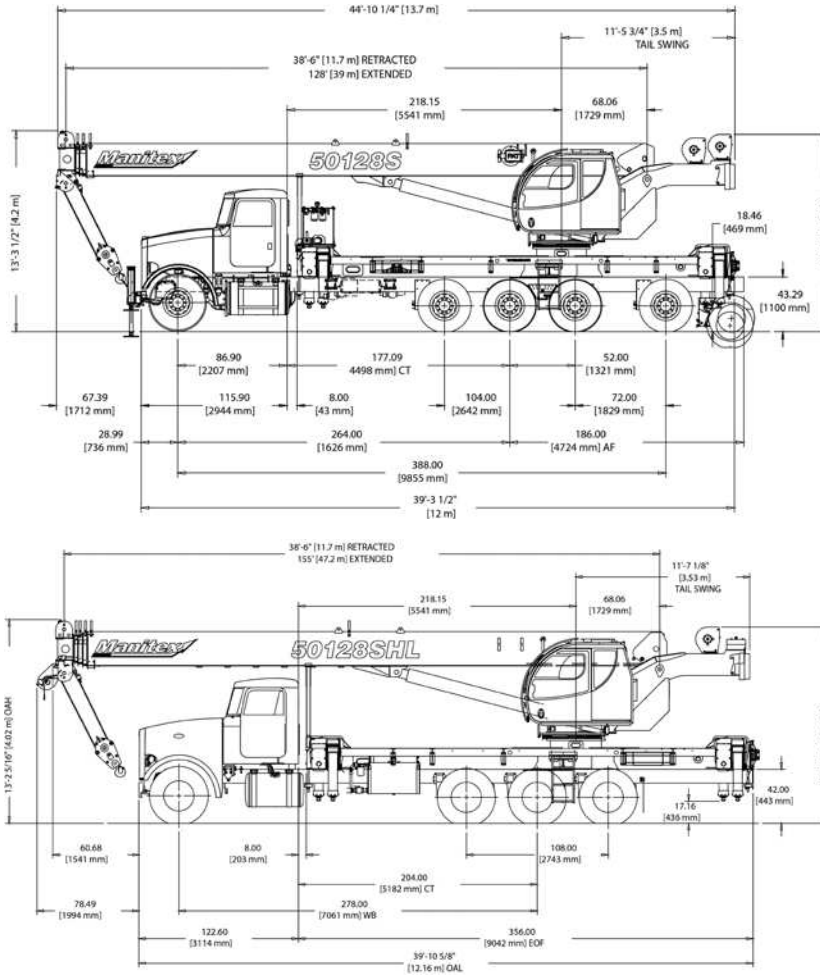

## Auxiliary Sheave Head

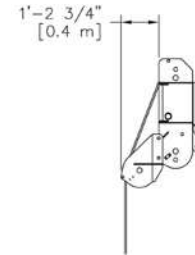

## CHASSIS DATA

Model	50128S	50128SHL
Frame section modulus at 180/360° area of operation*	27.0 in <sup>3</sup> 110,000 psi, 758,423 kPa	27.0 in <sup>3</sup> 110,000 psi, 758,423 kPa

\* Frame selection modulus at 360° area of operation requires front bumper stabilizer.

## TRUCK AXLE WEIGHT

Model	50128S	50128SHL
Min. truck axle W - Front**	9,100 lbs. (4,127 kg)	11,100 lbs. (5,034 kg)
Min. truck axle W - Rear**	13,985 lbs. (6,344 kg)	12,500 lbs. (5,670 kg)
Nominal Frame W	34 in. (864 mm)	34 in. (864 mm)

\*\* Minimum chassis weight is required to meet 85% stability requirements. Chassis data is general - not for engineering. Some dimensions depend on truck selection.

## CRANE WEIGHT

Model	50128S	50128SHL
Crane	38,955 lbs. (17,670 kg)	45,379 lbs. (20,584 kg)
Jib fixed	1,510 lbs. (685 kg)	1,510 lbs. (685 kg)
Jib telescopic	1,870 lbs. (848 kg)	1,870 lbs. (848 kg)
Aluminum Platforms	621 lbs. (282 kg)	621 lbs. (282 kg)

Notes: Additional axles required for federal bridge legal configuration - consult Manitex. Manitex highly recommends the addition of a front stabilizer and it may be required on some installations - consult Manitex.

Data published herein is intended as a guide only. Crane operation is subject to machine specific load charts and information.

# 50155S & SHL CHASSIS DATA

## Dimensions

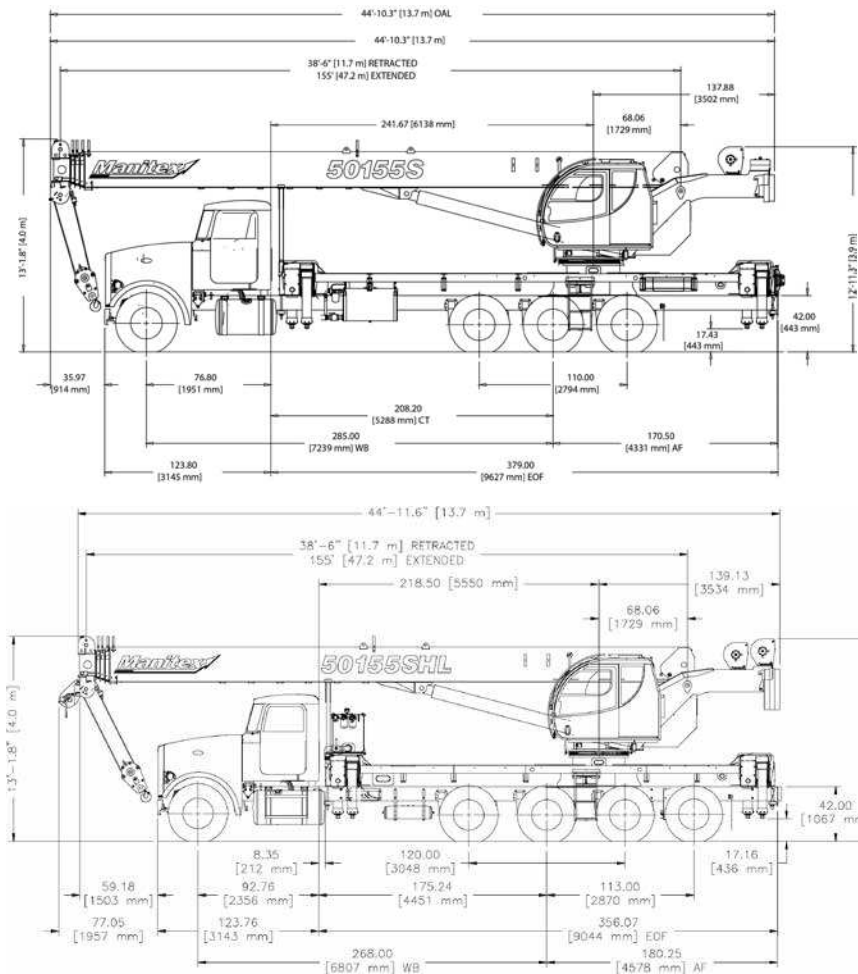

## Auxiliary Sheave Head

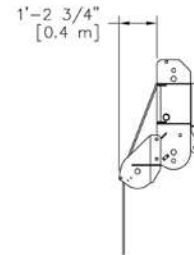

## CHASSIS DATA

Model	50155S	50155SHL
Frame section modulus at 180/360° area of operation*	27.0 in <sup>3</sup> 110,000 psi, 758,423 kPa	27.0 in <sup>3</sup> 110,000 psi, 758,423 kPa

\* Frame section modulus at 360° area of operation requires front bumper stabilizer.

## TRUCK AXLE WEIGHT

Model	50155S	50155SHL
Min. truck axle W - Front**	10,750 lbs. (4,876 kg)	9,500 lbs. (4,309 kg)
Min. truck axle W - Rear**	12,300 lbs. (5,579 kg)	13,400 lbs. (6,078 kg)
Nominal Frame W	34 in. (864 mm)	34 in. (864 mm)

\*\* Minimum chassis weight is required to meet 85% stability requirements. Chassis data is general - not for engineering. Some dimensions depend on truck selection.

## CRANE WEIGHT

Model	50155S	50155SHL
Crane	39,175 lbs. (17,796 kg)	45,605 lbs. (20,686 kg)
Jib fixed	1,510 lbs. (685 kg)	1,510 lbs. (685 kg)
Jib telescopic	N/A	N/A
Aluminum Platforms	621 lbs. (282 kg)	621 lbs. (282 kg)

Notes: Additional axles required for federal bridge legal configuration - consult ManiTex. ManiTex highly recommends the addition of a front stabilizer and it may be required on some installations - consult ManiTex.

Data published herein is intended as a guide only. Crane operation is subject to machine specific load charts and information.



# OUTRIGGER EXTENSION

## Full Extension

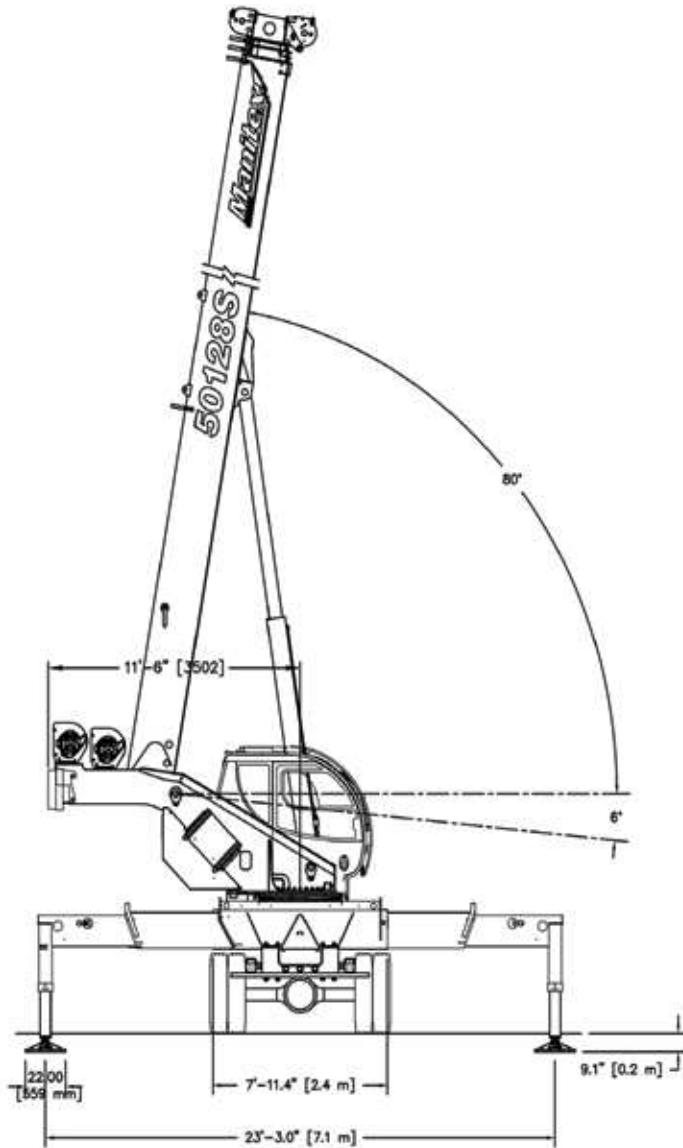

## Middle Extension

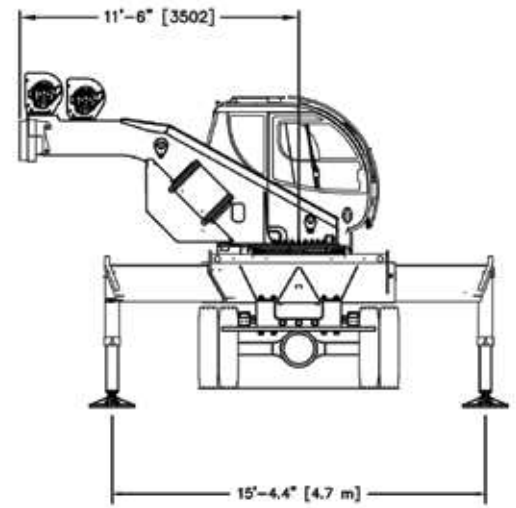

## Full Retraction

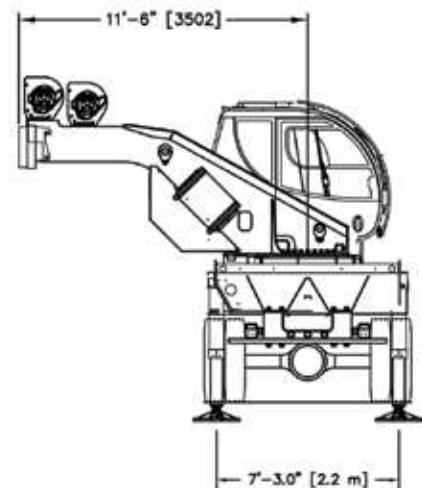

## SUB FRAME

- Pedestal sub-frame and stabilizers are mounted to chassis by threaded rods and clamp plates
- Sub-frame: Torsion resistant, rigid 4-plate design mounted under crane full length of truck frame
- Rear under-ride protection: Standard on factory mounted cranes

## ELECTRICAL SYSTEM

- State-of-the-art, weather-resistant components throughout
- Hermetically sealed enclosure includes power in relays and circuit status LEDs

Data published herein is intended as a guide only. Crane operation is subject to machine specific load charts and information.

# 5096S LOAD CHART: Main Boom

Lifting Capacities 4-section Boom 30.5 ft. - 96 ft.  
Outriggers Fully Extended

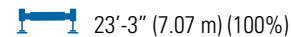

Boom Length (ft.)	Boom Length 30.5 ft.			Boom Length 48 ft. (A)			Boom Length 64 ft. (B)			Boom Length 80 ft. (C)			Boom Length 96 ft. (D)		
	CODE 1 Over Rear (lbs.)	CODE 3 Full 360° (lbs.)		CODE 1 Over Rear (lbs.)	CODE 3 Full 360° (lbs.)		CODE 1 Over Rear (lbs.)	CODE 3 Full 360° (lbs.)		CODE 1 Over Rear (lbs.)	CODE 3 Full 360° (lbs.)		CODE 1 Over Rear (lbs.)	CODE 3 Full 360° (lbs.)	
6	69	100,000	100,000												
8	65	90,400	90,400												
10	61	80,000	80,000	73	51,000	51,000									
12	56	71,800	71,800	70	51,000	51,000	76	40,000	40,000						
15	49	61,700	61,700	66	51,000	51,000	73	40,000	40,000	77	27,500	27,500			
20	34	46,100	46,100	59	47,000	47,000	69	37,700	37,700	74	27,500	27,500	78	18,000	18,000
25				52	36,800	36,800	64	30,400	30,400	70	24,300	24,300	75	18,000	18,000
30				44	29,480	25,890	59	27,040	26,420	66	21,280	21,280	72	17,500	17,500
35				34	22,630	19,320	53	23,100	19,830	62	19,050	19,050	69	16,240	16,240
40				20	18,020	15,030	47	18,510	15,550	58	16,980	15,820	65	14,660	14,660
45							40	15,230	12,550	53	15,250	12,810	62	13,280	12,970
50							32	12,750	10,320	49	13,000	10,580	58	12,130	10,730
55							21	10,810	8,590	44	11,070	8,860	54	11,080	9,020
60										38	9,530	7,500	50	9,680	7,650
65										31	8,260	6,380	46	8,420	6,540
70										22	7,200	5,450	41	7,360	5,620
75													36	6,470	4,840
80													30	5,700	4,170
85													23	5,020	3,580
90													8	4,410	3,050

**DEDUCTIONS FROM MAIN BOOM CAPACITIES FOR STOWED JIBS** - SJ = Stowed Jib, EJR = Erected Jib Retracted, EJE = Erected Jib Extended

	SJ	EJR	EJE
1,080 lbs.	1,080 lbs.	3,050 lbs.	3,470 lbs.
690 lbs.	690 lbs.	2,680 lbs.	2,590 lbs.
520 lbs.	520 lbs.	2,520 lbs.	2,720 lbs.
410 lbs.	410 lbs.	2,420 lbs.	2,580 lbs.
350 lbs.	350 lbs.	2,360 lbs.	2,490 lbs.

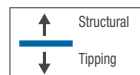

**NOTES:**

- All "on outriggers" loads are based on 85% tipping
- Loads based on crane on outriggers
- Loads above heavy line are based on structural rating
- Loads below heavy line are based on tipping rating

Data published herein is intended as a guide only. Crane operation is subject to machine specific load charts and information.

# 5096S BOOM DIAGRAM & JIB LOAD CAPACITIES

- RANGE DIAGRAM -

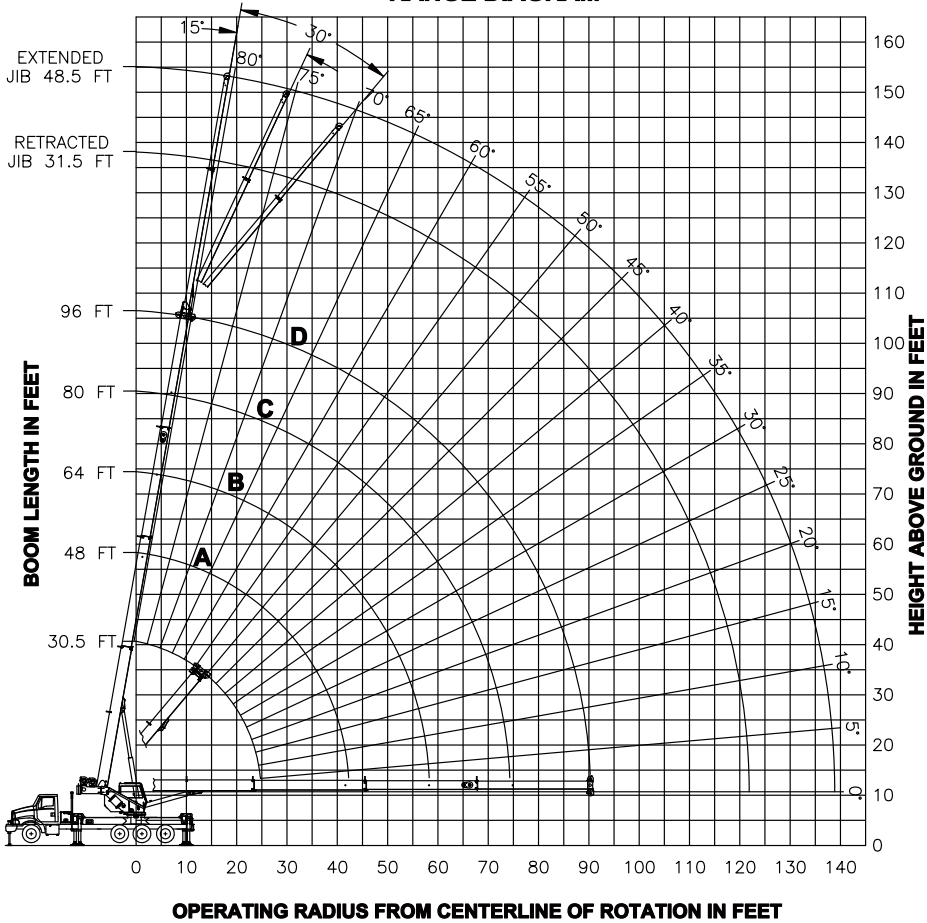

23'-3" (7.07 m) (100%)

23'-3" (7.07 m) (100%)





32 FT. RETRACTED JIB LOAD CAPACITIES								
Boom Length (ft.)	0° Offset		15° Offset		30° Offset		Over rear (lbs.)	Full 360° (lbs.)
	Over rear (lbs.)	Full 360° (lbs.)	Over rear (lbs.)	Full 360° (lbs.)	Over rear (lbs.)	Full 360° (lbs.)		
35	75	8,500	8,500					
40	73	8,500	8,500	76	7,600	7,600		
45	71	8,320	8,320	74	7,600	7,600	76	5,900
50	68	7,790	7,790	72	7,140	7,140	74	5,900
55	66	7,290	7,290	69	6,700	6,700	72	5,700
60	63	6,830	6,830	66	6,280	6,280	69	5,520
65	61	6,380	6,380	64	5,900	5,900	66	5,350
70	58	5,980	5,650	61	5,500	5,500	63	5,200
75	55	5,610	4,850	58	5,240	5,200	60	5,000
80	52	5,270	4,180	55	4,960	4,480	57	4,760
85	49	4,970	3,590	52	4,700	3,860	54	4,540
90	46	4,410	3,080	49	4,460	3,310	51	4,330
95	42	3,890	2,630	45	4,080	2,830	47	4,150
100	38	3,420	2,220	41	3,590	2,400	43	3,700
105	34	3,010	1,870	37	3,150	2,010	38	3,220
110	29	2,630	1,540	32	2,740	1,650	32	2,780
115	23	2,290	1,250	25	2,360	1,320	24	2,360
120	14	1,980	980	14	2,000	1,000		

49 FT. EXTENDED JIB LOAD CAPACITIES								
Boom Length (ft.)	0° Offset		15° Offset		30° Offset		Over rear (lbs.)	Full 360° (lbs.)
	Over rear (lbs.)	Full 360° (lbs.)	Over rear (lbs.)	Full 360° (lbs.)	Over rear (lbs.)	Full 360° (lbs.)		
40	75	5,600	5,600					
45	73	5,600	5,600	77	4,530	4,530		
50	71	5,600	5,600	75	4,530	4,530		
55	69	5,600	5,600	73	4,300	4,300	77	3,350
60	67	5,300	5,300	71	4,080	4,080	75	3,350
65	65	4,960	4,960	69	3,900	3,900	73	3,230
70	63	4,670	4,670	67	3,710	3,710	71	3,120
75	61	4,400	4,400	65	3,550	3,550	68	3,020
80	58	4,160	4,160	62	3,410	3,410	66	2,930
85	55	3,940	3,940	60	3,270	3,270	63	2,850
90	53	3,730	3,670	57	3,150	3,150	60	2,770
95	50	3,550	3,210	54	3,030	3,030	57	2,710
100	47	3,380	2,800	51	2,930	2,930	54	2,650
105	44	3,230	2,440	48	2,830	2,710	51	2,600
110	41	3,090	2,110	45	2,750	2,350	48	2,530
115	38	2,850	1,820	42	2,670	2,030	44	2,520
120	34	2,540	1,550	38	2,600	1,730	40	2,510
125	30	2,260	1,310	33	2,400	1,450	34	2,460
130	25	1,990	1,080	28	2,100	1,180	27	2,110
135	18	1,750	870	20	1,800	930		

# 50110S LOAD CHART: Main Boom





Lifting Capacities 4-section Boom 34 ft. - 110 ft. Outriggers Fully Extended

 23'-3" (7.07 m) (100%)

Boom Length (ft.)	Boom Length 34 ft.			Boom Length 42 ft. (A)			Boom Length 51 ft. (B)			Boom Length 59 ft. (C)			Boom Length 68 ft. (D)		
		CODE 1 Over Rear (lbs.)	CODE 3 Full 360° (lbs.)		CODE 1 Over Rear (lbs.)	CODE 3 Full 360° (lbs.)		CODE 1 Over Rear (lbs.)	CODE 3 Full 360° (lbs.)		CODE 1 Over Rear (lbs.)	CODE 3 Full 360° (lbs.)		CODE 1 Over Rear (lbs.)	CODE 3 Full 360° (lbs.)
6	71	100,000	100,000												
8	67.5	88,500	88,500	72	51,000	51,000	75.5	51,000	51,000	78	51,000	51,000			
10	63.5	78,200	78,200	69	51,000	51,000	73.5	51,000	51,000	76	51,000	51,000	78	47,380	47,380
12	60	70,200	70,200	66	51,000	51,000	71	51,000	51,000	74	51,000	51,000	76.5	45,140	45,140
15	53.5	60,600	60,600	61.5	51,000	51,000	67.5	51,000	51,000	71	49,770	49,770	74	42,140	42,140
20	42	46,200	46,200	53.5	46,700	46,700	61	46,400	46,400	65.5	44,310	44,310	69.5	37,820	37,820
25	26.5	35,800	35,800	44	36,300	36,300	54.5	36,700	36,700	60	36,900	36,900	65	32,530	32,530
30				33	29,340	25,770	47	29,720	26,320	54.5	29,930	26,640	60	28,560	26,900
35				15.5	22,960	18,990	38.5	23,490	19,560	48	23,770	19,860	55	23,990	20,100
40							27.5	18,680	15,160	40.5	18,960	15,460	49.5	19,180	15,690
45							7	15,170	12,010	32	15,510	12,370	43.5	15,730	12,600
50										20.5	12,910	10,060	37	13,140	10,310
55													28.5	11,110	8,530
60													16.5	9,470	7,100

**DEDUCTIONS FROM MAIN BOOM CAPACITIES FOR STOWED JIBS** - SJ = Stowed Jib, EJR = Erected Jib Retracted, EJE = Erected Jib Extended

<b>SJ</b>	1,150 lbs.	930 lbs.	770 lbs.	670 lbs.	580 lbs.
<b>EJR</b>	2,940 lbs.	2,770 lbs.	2,640 lbs.	2,560 lbs.	2,490 lbs.
<b>EJE</b>	3,320 lbs.	3,080 lbs.	2,890 lbs.	2,780 lbs.	2,680 lbs.

Boom Length (ft.)	Boom Length 76 ft. (E)			Boom Length 85 ft. (F)			Boom Length 93 ft. (G)			Boom Length 102 ft. (H)			Boom Length 110 ft. (I)		
		CODE 1 Over Rear (lbs.)	CODE 3 Full 360° (lbs.)		CODE 1 Over Rear (lbs.)	CODE 3 Full 360° (lbs.)		CODE 1 Over Rear (lbs.)	CODE 3 Full 360° (lbs.)		CODE 1 Over Rear (lbs.)	CODE 3 Full 360° (lbs.)		CODE 1 Over Rear (lbs.)	CODE 3 Full 360° (lbs.)
12	78.5	39,530	39,530												
15	76	37,080	37,080	78	30,830	30,830									
20	72	31,860	31,860	74.5	26,790	26,790	76.5	24,480	24,480	78	21,860	21,860			
25	68	27,740	27,740	71	23,230	23,230	73	21,500	21,500	75	19,820	19,820	76.5	15,500	15,500
30	64	24,220	24,220	67.5	20,390	20,390	70	19,210	19,210	72.5	17,730	17,730	74	15,500	15,500
35	59.5	21,390	20,260	63.5	18,270	18,270	66.5	17,050	17,050	69.5	15,830	15,830	71.5	14,660	14,660
40	55	19,300	15,840	60	16,260	15,980	63	15,260	15,260	66.5	14,210	14,210	68.5	13,320	13,320
45	50	15,870	12,750	55.5	14,570	12,870	59.5	13,700	12,960	63	12,810	12,810	66	12,080	12,080
50	45	13,280	10,450	51.5	13,130	10,580	56	12,370	10,660	60	11,600	10,740	63	10,970	10,800
55	39	11,260	8,680	47	11,380	8,810	52	11,220	8,890	56.5	10,530	8,970	59.5	10,000	9,020
60	32	9,640	7,270	41.5	9,760	7,400	47.5	9,840	7,490	53	9,840	7,560	56.5	9,330	7,610
65	23.5	8,300	6,120	36	8,430	6,250	43	8,510	6,340	49	8,590	6,410	53.5	8,530	6,470
70	7	7,150	5,130	29.5	7,320	5,300	38	7,410	5,390	45	7,480	5,460	50	7,530	5,520
75				20.5	6,370	4,480	32.5	6,470	4,580	40.5	6,540	4,660	46	6,590	4,710
80							25.5	5,650	3,890	36	5,740	3,970	42	5,790	4,030
85							15	4,940	3,280	30	5,030	3,380	37.5	5,090	3,430
90										23	4,420	2,850	33	4,480	2,910
95										12	3,860	2,370	27	3,930	2,450
100													19	3,440	2,040

**DEDUCTIONS FROM MAIN BOOM CAPACITIES FOR STOWED JIBS** - SJ = Stowed Jib, EJR = Erected Jib Retracted, EJE = Erected Jib Extended

<b>SJ</b>	520 lbs.	460 lbs.	420 lbs.	390 lbs.	360 lbs.
<b>EJR</b>	2,440 lbs.	2,400 lbs.	2,370 lbs.	2,340 lbs.	2,320 lbs.
<b>EJE</b>	2,610 lbs.	2,550 lbs.	2,510 lbs.	2,460 lbs.	2,430 lbs.

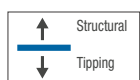

**NOTES:**

- All "on outriggers" loads are based on 85% tipping
- Loads based on crane on outriggers
- Loads above heavy line are based on structural rating
- Loads below heavy line are based on tipping rating

Data published herein is intended as a guide only. Crane operation is subject to machine specific load charts and information.

# 50110S BOOM DIAGRAM & JIB LOAD CAPACITIES

- RANGE DIAGRAM -

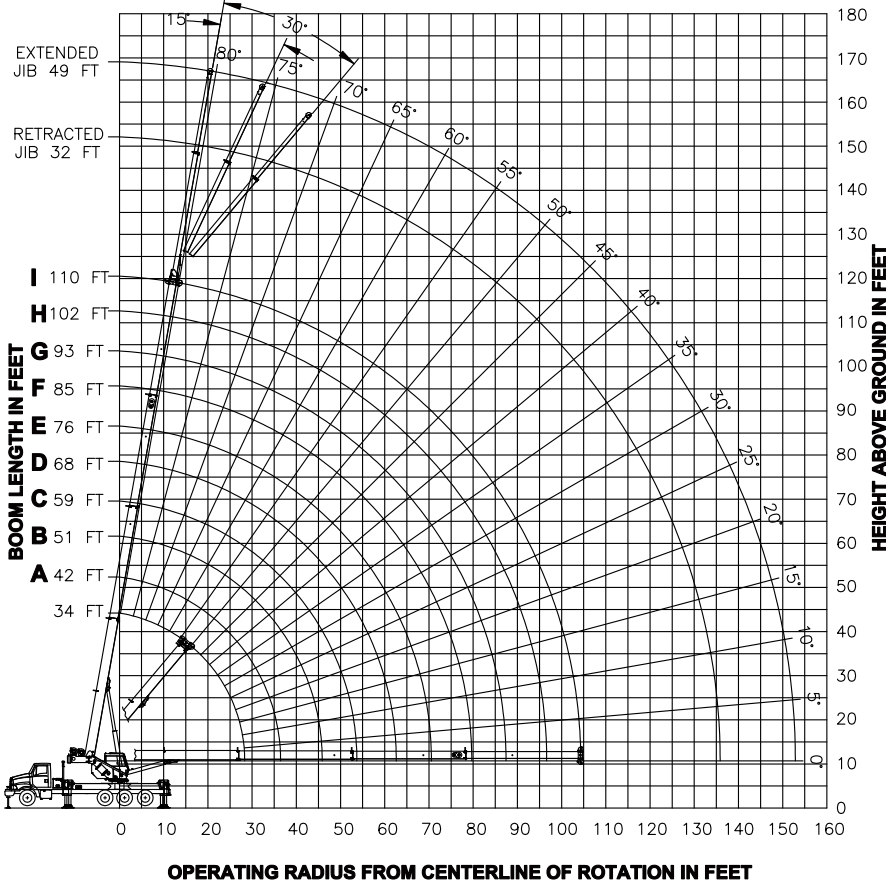

23'-3" (7.07 m) (100%)

23'-3" (7.07 m) (100%)





32 FT. RETRACTED JIB LOAD CAPACITIES									
Boom Length (ft.)	0° Offset		15° Offset		30° Offset				
	Over rear (lbs.)	Full 360° (lbs.)	Over rear (lbs.)	Full 360° (lbs.)	Over rear (lbs.)	Full 360° (lbs.)	Over rear (lbs.)	Full 360° (lbs.)	
35	76.5	7,300	7,300						
40	74.5	7,300	7,300						
45	72.5	7,300	7,300	76	6,500	6,500			
50	70.5	7,300	7,300	73.5	6,500	6,500	76	5,800	5,800
55	68.5	6,980	6,980	71.5	6,500	6,500	74	5,800	5,800
60	66.5	6,600	6,600	69.5	6,120	6,120	72	5,750	5,750
65	64	6,230	6,230	67	5,780	5,780	69.5	5,450	5,450
70	62	5,870	5,330	65	5,450	5,450	67	5,160	5,160
75	59.5	5,530	4,520	62.5	5,160	4,930	64.5	4,900	4,900
80	57	5,110	3,830	60	4,880	4,200	62	4,670	4,500
85	54.5	4,690	3,240	57.5	4,630	3,570	59.5	4,450	3,830
90	52	4,270	2,720	54.5	4,400	3,010	56.5	4,250	3,250
95	49	3,730	2,260	51.5	3,990	2,530	53.5	4,070	2,730
100	46	3,250	1,860	48.5	3,480	2,090	50.5	3,650	2,260
105	43	2,820	1,490	45.5	3,020	1,700	47	3,160	1,840
110	39.5	2,440	1,170	42	2,610	1,350	43.5	2,720	1,460
115	35.5	2,080	870	38	2,230	1,020	39	2,320	1,110
120	31.5	1,770		34	1,890		34.5	1,940	790
125	26.5	1,470		29	1,570		29	1,590	
130	20.5	1,200		22	1,260		20	1,240	
135	10	950							

49 FT. EXTENDED JIB LOAD CAPACITIES									
Boom Length (ft.)	0° Offset		15° Offset		30° Offset				
	Over rear (lbs.)	Full 360° (lbs.)	Over rear (lbs.)	Full 360° (lbs.)	Over rear (lbs.)	Full 360° (lbs.)	Over rear (lbs.)	Full 360° (lbs.)	
40	77	5,400	5,400						
45	75	5,400	5,400						
50	73.5	5,400	5,400	77	4,700	4,700			
55	71.5	5,400	5,400	75	4,700	4,700			
60	69.5	5,400	5,400	73.5	4,480	4,480	77	3,520	3,520
65	68	5,230	5,230	71.5	4,280	4,280	75	3,520	3,520
70	66	4,930	4,930	69.5	4,100	4,100	73.5	3,410	3,410
75	64	4,660	4,660	67.5	3,940	3,940	71	3,310	3,310
80	62	4,410	4,410	65.5	3,790	3,790	69	3,210	3,210
85	60	4,170	3,840	63.5	3,650	3,650	67	3,130	3,130
90	57.5	3,950	3,320	61.5	3,520	3,520	64.5	3,050	3,050
95	55.5	3,750	2,850	59	3,400	3,280	62	2,980	2,980
100	53	3,560	2,440	57	3,290	2,830	59.5	2,910	2,910
105	50.5	3,380	2,080	54.5	3,190	2,420	57	2,860	2,700
110	48	3,000	1,750	52	3,050	2,060	54.5	2,810	2,300
115	45.5	2,650	1,450	49	2,920	1,730	51.5	2,760	1,940
120	42.5	2,330	1,180	46	2,570	1,430	48.5	2,730	1,610
125	39.5	2,030	930	43	2,250	1,150	45	2,400	1,300
130	36	1,760		39.5	1,950	890	41	2,070	1,010
135	32	1,510		35.5	1,670		36.5	1,750	
140	28	1,280		31	1,410		31	1,450	
145	22.5	1,070		25	1,160				
150	15	870		15.5	900				

# 50110SHL LOAD CHART: Main Boom





Lifting Capacities 4-section Boom 34 ft. - 110 ft. - Full Outrigger Extension

 23'-3" (7.07 m) (100%)

Boom Length (ft.)	Boom Length 34 ft.			Boom Length 42 ft. (A)			Boom Length 51 ft. (B)			Boom Length 59 ft. (C)			Boom Length 68 ft. (D)		
		CODE 1 Over Rear (lbs.)	CODE 3 Full 360° (lbs.)		CODE 1 Over Rear (lbs.)	CODE 3 Full 360° (lbs.)		CODE 1 Over Rear (lbs.)	CODE 3 Full 360° (lbs.)		CODE 1 Over Rear (lbs.)	CODE 3 Full 360° (lbs.)		CODE 1 Over Rear (lbs.)	CODE 3 Full 360° (lbs.)
6	71	100,000	100,000												
8	67.5	88,500	88,500	72	51,000	51,000	75.5	51,000	51,000	78	51,000	51,000			
10	63.5	78,200	78,200	69	51,000	51,000	73.5	51,000	51,000	76	51,000	51,000	78	47,380	47,380
12	60	70,200	70,200	66	51,000	51,000	71	51,000	51,000	74	51,000	51,000	76.5	45,140	45,140
15	53.5	60,600	60,600	61.5	51,000	51,000	67.5	51,000	51,000	71	49,770	49,770	74	42,140	42,140
20	42	48,500	48,500	53.5	47,800	47,800	61	46,400	46,400	65.5	44,310	44,310	69.5	37,820	37,820
25	26.5	37,600	37,600	44	38,100	38,100	54.5	38,500	38,500	60	38,000	38,000	65	32,530	32,530
30				33	30,500	30,500	47	30,900	30,900	54.5	31,100	31,100	60	28,560	28,560
35				15.5	23,990	23,990	38.5	25,480	24,980	48	25,710	25,280	55	25,150	25,150
40							27.5	21,420	19,630	40.5	21,670	19,930	49.5	21,860	20,160
45							7	15,390	15,390	32	18,530	16,170	43.5	18,730	16,400
50										20.5	16,010	13,360	37	16,230	13,610
55													28.5	14,180	11,450
60													16.5	12,450	9,720

**DEDUCTIONS FROM MAIN BOOM CAPACITIES FOR STOWED JIBS** - SJ = Stowed Jib, EJR = Erected Jib Retracted, EJE = Erected Jib Extended

<b>SJ</b>	1,150 lbs.	930 lbs.	770 lbs.	670 lbs.	580 lbs.
<b>EJR</b>	2,940 lbs.	2,770 lbs.	2,640 lbs.	2,560 lbs.	2,490 lbs.
<b>EJE</b>	3,320 lbs.	3,080 lbs.	2,890 lbs.	2,780 lbs.	2,680 lbs.

Boom Length (ft.)	Boom Length 76 ft. (E)			Boom Length 85 ft. (F)			Boom Length 93 ft. (G)			Boom Length 102 ft. (H)			Boom Length 110 ft. (I)		
		CODE 1 Over Rear (lbs.)	CODE 3 Full 360° (lbs.)		CODE 1 Over Rear (lbs.)	CODE 3 Full 360° (lbs.)		CODE 1 Over Rear (lbs.)	CODE 3 Full 360° (lbs.)		CODE 1 Over Rear (lbs.)	CODE 3 Full 360° (lbs.)		CODE 1 Over Rear (lbs.)	CODE 3 Full 360° (lbs.)
12	78.5	39,530	39,530												
15	76	37,080	37,080	78	30,830	30,830									
20	72	31,860	31,860	74.5	26,790	26,790	76.5	24,480	24,480	78	21,860	21,860			
25	68	27,740	27,740	71	23,230	23,230	73	21,500	21,500	75	19,820	19,820	76.5	15,500	15,500
30	64	24,220	24,220	67.5	20,390	20,390	70	19,210	19,210	72.5	17,730	17,730	74	15,500	15,500
35	59.5	21,390	21,390	63.5	18,270	18,270	66.5	17,050	17,050	69.5	15,830	15,830	71.5	14,660	14,660
40	55	19,300	19,300	60	16,260	16,260	63	15,260	15,260	66.5	14,210	14,210	68.5	13,320	13,320
45	50	17,310	16,540	55.5	14,570	14,570	59.5	13,700	13,700	63	12,810	12,810	66	12,080	12,080
50	45	15,610	13,760	51.5	13,130	13,130	56	12,370	12,370	60	11,600	11,600	63	10,970	10,970
55	39	14,160	11,600	47	11,920	11,730	52	11,220	11,220	56.5	10,530	10,530	59.5	10,000	10,000
60	32	12,610	9,890	41.5	10,840	10,020	47.5	10,210	10,100	53	9,840	9,840	56.5	9,330	9,330
65	23.5	11,160	8,490	36	10,010	8,630	43	9,590	8,710	49	9,000	8,790	53.5	8,530	8,530
70	7	8,290	7,300	29.5	9,320	7,470	38	8,780	7,560	45	8,240	7,630	50	7,810	7,690
75				20.5	8,580	6,480	32.5	8,060	6,580	40.5	7,560	6,660	46	7,160	6,710
80							25.5	7,420	5,740	36	6,960	5,830	42	6,590	5,880
85							15	6,860	5,010	30	6,410	5,100	37.5	6,070	5,160
90										23	5,920	4,470	33	5,600	4,530
95										12	5,490	3,890	27	5,170	3,970
100													19	4,780	3,470

**DEDUCTIONS FROM MAIN BOOM CAPACITIES FOR STOWED JIBS** - SJ = Stowed Jib, EJR = Erected Jib Retracted, EJE = Erected Jib Extended

<b>SJ</b>	520 lbs.	460 lbs.	420 lbs.	390 lbs.	360 lbs.
<b>EJR</b>	2,440 lbs.	2,400 lbs.	2,370 lbs.	2,340 lbs.	2,320 lbs.
<b>EJE</b>	2,610 lbs.	2,550 lbs.	2,510 lbs.	2,460 lbs.	2,430 lbs.

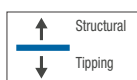

**NOTES:**

- All "on outriggers" loads are based on 85% tipping
- Loads above heavy line are based on structural rating
- Loads based on crane on outriggers
- Loads below heavy line are based on tipping rating

Data published herein is intended as a guide only. Crane operation is subject to machine specific load charts and information.

# 50110SHL BOOM DIAGRAM & JIB LOAD CAPACITIES

- RANGE DIAGRAM -

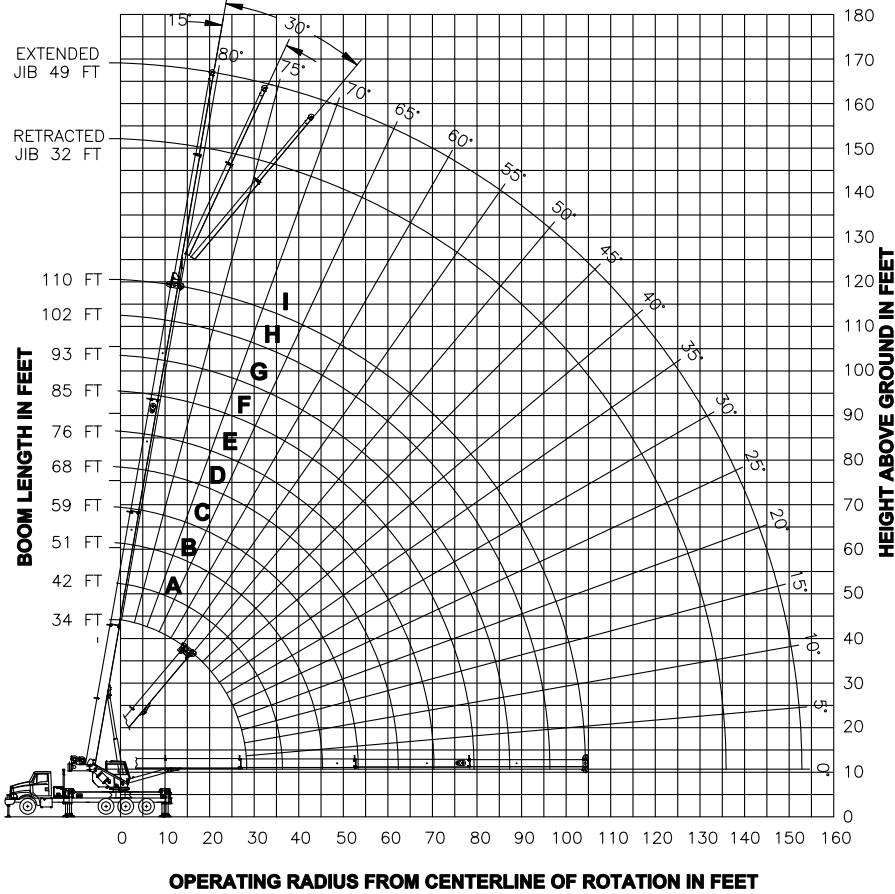

23'-3" (7.07 m) (100%)

23'-3" (7.07 m) (100%)

32 FT. RETRACTED JIB LOAD CAPACITIES									
Boom Length (ft.)	0° Offset		15° Offset			30° Offset			
	Over rear (lbs.)	Full 360° (lbs.)	Over rear (lbs.)	Full 360° (lbs.)	Over rear (lbs.)	Full 360° (lbs.)	Over rear (lbs.)	Full 360° (lbs.)	
40	76.5	7,300	7,300						
40	74.5	7,300	7,300						
45	72.5	7,300	7,300	76	6,500	6,500			
50	70.5	7,300	7,300	73.5	6,500	6,500	76	5,800	5,800
55	68.5	6,980	6,980	71.5	6,500	6,500	74	5,800	5,800
60	66.5	6,600	6,600	69.5	6,120	6,120	72	5,750	5,750
65	64	6,230	6,230	67	5,780	5,780	69.5	5,450	5,450
70	62	5,870	5,870	65	5,450	5,450	67	5,160	5,160
75	59.5	5,530	5,530	62.5	5,160	5,160	64.5	4,900	4,900
80	57	5,110	5,110	60	4,880	4,880	62	4,670	4,670
85	54.5	4,690	4,690	57.5	4,630	4,630	59.5	4,450	4,450
90	52	4,280	4,280	54.5	4,400	4,400	56.5	4,250	4,250
95	49	3,920	3,760	51.5	4,070	4,030	53.5	4,070	4,070
100	46	3,570	3,270	48.5	3,700	3,510	50.5	3,820	3,680
105	43	3,250	2,830	45.5	3,370	3,040	47	3,480	3,180
110	39.5	2,950	2,440	42	3,050	2,620	43.5	3,140	2,730
115	35.5	2,670	2,080	38	2,770	2,230	39	2,830	2,320
120	31.5	2,420	1,760	34	2,500	1,880	34.5	2,540	1,940
125	26.5	2,180	1,460	29	2,240	1,560	29	2,260	1,580
130	20.5	1,960	1,190	22	2,000	1,250	20	1,970	1,230
135	10	1,760	930						

49 FT. EXTENDED JIB LOAD CAPACITIES									
Boom Length (ft.)	0° Offset		15° Offset			30° Offset			
	Over rear (lbs.)	Full 360° (lbs.)	Over rear (lbs.)	Full 360° (lbs.)	Over rear (lbs.)	Full 360° (lbs.)	Over rear (lbs.)	Full 360° (lbs.)	
40	77	5,400	5,400						
45	75	5,400	5,400						
50	73.5	5,400	5,400	77	4,700	4,700			
55	71.5	5,400	5,400	75	4,700	4,700			
60	69.5	5,400	5,400	73.5	4,480	4,480	77	3,520	3,520
65	68	5,230	5,230	71.5	4,280	4,280	75	3,520	3,520
70	66	4,930	4,930	69.5	4,100	4,100	73.5	3,410	3,410
75	64	4,660	4,660	67.5	3,940	3,940	71	3,310	3,310
80	62	4,410	4,410	65.5	3,790	3,790	69	3,210	3,210
85	60	4,170	4,170	63.5	3,650	3,650	67	3,130	3,130
90	57.5	3,950	3,950	61.5	3,520	3,520	64.5	3,050	3,050
95	55.5	3,750	3,750	59	3,400	3,400	62	2,980	2,980
100	53	3,560	3,560	57	3,290	3,290	59.5	2,910	2,910
105	50.5	3,380	3,380	54.5	3,190	3,190	57	2,860	2,860
110	48	3,220	3,020	52	3,050	3,050	54.5	2,810	2,810
115	45.5	2,980	2,660	49	2,920	2,920	51.5	2,760	2,760
120	42.5	2,730	2,330	46	2,800	2,580	48.5	2,730	2,730
125	39.5	2,500	2,030	43	2,640	2,250	45	2,650	2,400
130	36	2,290	1,760	39.5	2,410	1,950	41	2,480	2,070
135	32	2,090	1,510	35.5	2,190	1,660	36.5	2,240	1,750
140	28	1,890	1,270	31	1,970	1,440	31	2,000	1,440
145	22.5	1,720	1,060	25	1,770	1,150			
150	15	1,550	850	15.5	1,570	890			

# 50128S LOAD CHART: Main Boom

Lifting Capacities 4-section Boom 38.5 ft. - 128 ft. - Full Outrigger Extension

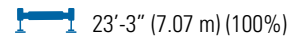

Jib (ft.)	Boom Length 38.5 ft.			Boom Length 53 ft. (A)			Boom Length 66 ft. (B)			Boom Length 78 ft. (C)		
	Jib (ft.)	CODE 1 Over Rear (lbs.)	CODE 3 Full 360° (lbs.)	Jib (ft.)	CODE 1 Over Rear (lbs.)	CODE 3 Full 360° (lbs.)	Jib (ft.)	CODE 1 Over Rear (lbs.)	CODE 3 Full 360° (lbs.)	Jib (ft.)	CODE 1 Over Rear (lbs.)	CODE 3 Full 360° (lbs.)
6	73.5	100,000	100,000									
8	70.5	86,600	86,600									
10	67	76,400	76,400	74.5	51,000	51,000	78	51,000	51,000			
12	64	68,400	68,400	72.5	51,000	51,000	76.5	51,000	51,000	79	41,710	41,710
15	59	59,000	59,000	68.5	51,000	51,000	73.5	46,650	46,650	77	37,880	37,880
20	49.5	47,670	47,670	62.5	45,700	45,700	69	39,300	39,300	73	32,140	32,140
25	38.5	36,900	36,900	56	37,680	37,680	64	33,450	33,450	69	27,890	27,890
30	23.5	29,590	26,680	49.5	30,410	27,890	59	29,140	28,440	65	24,230	24,230
35				41.5	25,170	20,650	54	25,490	21,160	61	21,310	21,310
40				32	20,620	15,940	48	21,090	16,440	56.5	19,160	16,730
45				18.5	16,770	12,610	42	17,270	13,130	52	17,070	13,410
50							34.5	14,390	10,670	46.5	14,660	10,950
55							25	12,140	8,760	41	12,420	9,050
60							7	9,790	7,200	35	10,620	7,540
65										27	9,140	6,300
70										16	7,890	5,260
<b>SJ</b>		1,230 lbs.			890 lbs.			720 lbs.			610 lbs.	
<b>EJR</b>		2,840 lbs.			2,620 lbs.			2,500 lbs.			2,430 lbs.	
<b>EJE</b>		3,170 lbs.			2,860 lbs.			2,700 lbs.			2,600 lbs.	

Jib (ft.)	Boom Length 91 ft. (D)			Boom Length 103 ft. (E)			Boom Length 116 ft. (F)			Boom Length 128 ft. (G)		
	Jib (ft.)	CODE 1 Over Rear (lbs.)	CODE 3 Full 360° (lbs.)	Jib (ft.)	CODE 1 Over Rear (lbs.)	CODE 3 Full 360° (lbs.)	Jib (ft.)	CODE 1 Over Rear (lbs.)	CODE 3 Full 360° (lbs.)	Jib (ft.)	CODE 1 Over Rear (lbs.)	CODE 3 Full 360° (lbs.)
15	79	30,000	30,000									
20	76	26,010	26,010	78.5	22,790	22,790						
25	72.5	22,620	22,620	75.5	20,160	20,160	78	17,660	17,660			
30	69.5	20,000	20,000	72.5	18,080	18,080	75.5	16,060	16,060	77.5	13,000	13,000
35	66	17,710	17,710	70.5	16,070	16,070	73	14,480	14,480	75.5	12,760	12,760
40	62.5	15,740	15,740	67.5	14,360	14,360	70.5	13,050	13,050	73	11,760	11,760
45	59	14,050	13,620	64	12,900	12,900	68	11,780	11,780	71	10,800	10,800
50	55	12,620	11,150	60.5	11,610	11,290	65	10,640	10,640	68.5	10,000	10,000
55	50.5	11,380	9,250	57	10,500	9,380	62	9,890	9,490	66	9,130	9,130
60	46.5	10,340	7,740	53.5	9,760	7,870	59	8,970	7,970	63.5	8,320	8,050
65	41.5	9,340	6,510	50	8,860	6,640	56	8,160	6,740	60.5	7,570	6,820
70	36.5	8,110	5,490	46	8,060	5,620	53	7,430	5,720	58	6,910	5,790
75	30	7,060	4,620	41.5	7,190	4,750	49.5	6,780	4,860	55	6,300	4,930
80	22	6,160	3,870	37	6,300	4,020	46	6,180	4,120	52	5,750	4,190
85	7	5,290	3,200	31.5	5,520	3,380	42.5	5,620	3,480	49	5,250	3,550
90				25	4,830	2,810	38	4,940	2,920	46	4,790	3,000
95				15.5	4,210	2,300	33.5	4,340	2,430	42	4,370	2,510
100							28.5	3,800	1,990	38.5	3,870	2,070
105							21.5	3,310	1,590	34	3,390	1,680
110							7.5	2,860	1,220	29.5	2,960	1,320
115										23.5	2,560	1,000
120										15	2,200	
<b>SJ</b>		520 lbs.			460 lbs.			410 lbs.			370 lbs.	
<b>EJR</b>		2,370 lbs.			2,330 lbs.			2,300 lbs.			2,280 lbs.	
<b>EJE</b>		2,520 lbs.			2,460 lbs.			2,410 lbs.			2,380 lbs.	

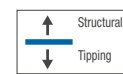

**DEDUCTIONS FROM MAIN BOOM CAPACITIES FOR STOWED JIBS**

SJ = Stowed Jib,  
EJR = Erected Jib Retracted,  
EJE = Erected Jib Extended

**NOTES:**

- Loads based on crane on outriggers
- All "on outriggers" loads are based on 85% tipping
- Loads above heavy line are based on structural rating
- Loads below heavy line are based on tipping rating

Data published herein is intended as a guide only. Crane operation is subject to machine specific load charts and information.



# 50128S BOOM DIAGRAM & JIB LOAD CAPACITIES

- RANGE DIAGRAM -

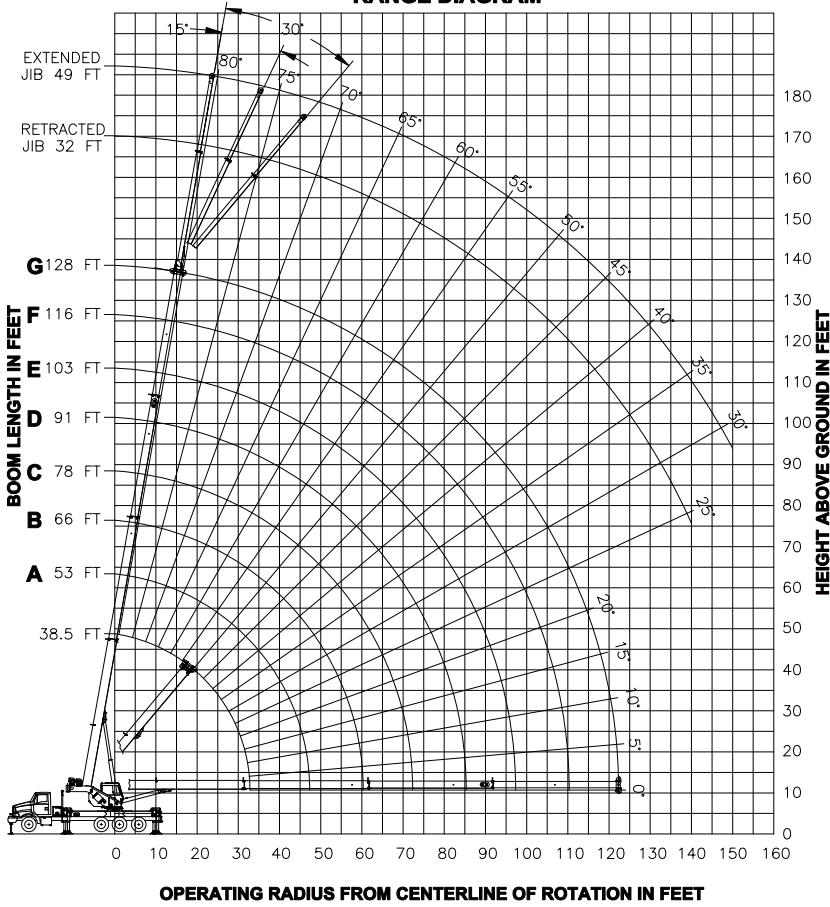

23'-3" (7.07 m) (100%)

23'-3" (7.07 m) (100%)





32 FT. RETRACTED JIB LOAD CAPACITIES								
Boom Length (ft.)	0° Offset		15° Offset		30° Offset			
	Over rear (lbs.)	Full 360° (lbs.)	Over rear (lbs.)	Full 360° (lbs.)	Over rear (lbs.)	Full 360° (lbs.)	Over rear (lbs.)	Full 360° (lbs.)
35	78	5,400	5,400					
40	76.5	5,400	5,400	79.5	5,400	5,400		
45	75	5,400	5,400	78	5,400	5,400		
50	73.5	5,400	5,400	76.5	5,400	5,400	79	5,400
55	72	5,400	5,400	74.5	5,400	5,400	77	5,400
60	70	5,400	5,400	73	5,400	5,400	75	5,400
65	68.5	5,400	5,400	71	5,400	5,400	73	5,240
70	66.5	5,210	5,210	69	5,230	5,230	71.5	4,990
75	64.5	4,740	4,740	67	4,970	4,970	69.5	4,750
80	62.5	4,300	4,030	65	4,570	4,480	67.5	4,520
85	60.5	3,890	3,390	63	4,140	3,790	65	4,310
90	58	3,510	2,820	61	3,740	3,190	63	3,930
95	55.5	3,160	2,320	58.5	3,360	2,650	60.5	3,540
100	53	2,820	1,880	56	3,010	2,180	58	3,170
105	50.5	2,520	1,490	53.5	2,690	1,760	55.5	2,830
110	48	2,230	1,130	50.5	2,390	1,380	52.5	2,510
115	45.5	1,960	810	48	2,100	1,030	49.5	2,210
120	42.5	1,700		45	1,830		46.5	1,920
125	39.5	1,470		42	1,580		43	1,660
130	36.5	1,240		38.5	1,350		39.5	1,400
135	32.5	1,030		34.5	1,120		35.5	1,160
140	28.5	840		30.5	910		30.5	920





49 FT. EXTENDED JIB LOAD CAPACITIES								
Boom Length (ft.)	0° Offset		15° Offset		30° Offset			
	Over rear (lbs.)	Full 360° (lbs.)	Over rear (lbs.)	Full 360° (lbs.)	Over rear (lbs.)	Full 360° (lbs.)	Over rear (lbs.)	Full 360° (lbs.)
40	78	4,300	4,300					
45	76.5	4,300	4,300					
50	75	4,300	4,300	79.5	4,300	4,300		
55	73.5	4,300	4,300	78	4,300	4,300		
60	72	4,300	4,300	76.5	4,300	4,300	79.5	3,700
65	70.5	4,300	4,300	75	4,300	4,300	78	3,590
70	69	4,300	4,300	73.5	4,230	4,230	76	3,490
75	67.5	4,300	4,300	71.5	4,080	4,080	74	3,390
80	66	4,240	4,240	70	3,930	3,930	72.5	3,300
85	64.5	4,030	4,010	68.5	3,760	3,760	70.5	3,220
90	63	3,740	3,430	66.5	3,590	3,590	69	3,140
95	61	3,430	2,930	64.5	3,420	3,420	67	3,070
100	59	3,120	2,480	62.5	3,270	2,950	65	3,000
105	57	2,840	2,080	60.5	3,100	2,510	63	2,940
110	54.5	2,560	1,720	58	2,810	2,120	61	2,880
115	52	2,310	1,400	56	2,540	1,760	58.5	2,720
120	49.5	2,070	1,100	53.5	2,280	1,430	56	2,450
125	47	1,840	830	51	2,040	1,130	53.5	2,190
130	44.5	1,630		48	1,810	860	50.5	1,940
135	42	1,430		45.5	1,590		47.5	1,700
140	39.5	1,240		42.5	1,390		44.5	1,480
145	36.5	1,060		39.5	1,190		41	1,260
150	33	900		36	1,000		37	1,050
155				32	820		32.5	850

# 50128SHL LOAD CHART: Main Boom

Lifting Capacities 4-section Boom 38.5 ft. - 128 ft. - Full Outrigger Extension

 23'-3" (7.07 m) (100%)

Boom Length (ft.)	Boom Length 38.5 ft.			Boom Length 53 ft. (A)			Boom Length 66 ft. (B)			Boom Length 78 ft. (C)		
		CODE 1 Over Rear (lbs.)	CODE 3 Full 360° (lbs.)		CODE 1 Over Rear (lbs.)	CODE 3 Full 360° (lbs.)		CODE 1 Over Rear (lbs.)	CODE 3 Full 360° (lbs.)		CODE 1 Over Rear (lbs.)	CODE 3 Full 360° (lbs.)
6	73.5	100,000	100,000									
8	70.5	86,600	86,600									
10	67	76,400	76,400	74.5	51,000	51,000	78	51,000	51,000			
12	64	68,400	68,400	72.5	51,000	51,000	76.5	51,000	51,000	79	41,710	41,710
15	59	59,000	59,000	68.5	51,000	51,000	73.5	46,650	46,650	77	37,880	37,880
20	49.5	47,700	47,700	62.5	45,700	45,700	69	39,300	39,300	73	32,140	32,140
25	38.5	38,300	38,300	56	38,400	38,400	64	33,450	33,450	69	27,890	27,890
30	23.5	30,200	30,200	49.5	31,590	31,590	59	29,140	29,140	65	24,230	24,230
35				41.5	26,180	23,590	54	25,490	24,100	61	21,310	21,310
40				32	22,080	18,360	48	22,480	18,860	56.5	19,160	19,150
45				18.5	18,340	14,670	42	19,280	15,190	52	17,070	15,470
50							34.5	16,710	12,460	46.5	15,330	12,740
55							25	14,420	10,350	41	13,850	10,630
60							7	9,790	8,620	35	12,560	8,960
65										27	11,000	7,590
70										16	9,600	6,440
<b>SJ</b>		1,230 lbs.			890 lbs.			720 lbs.			610 lbs.	
<b>EJR</b>		2,840 lbs.			2,620 lbs.			2,500 lbs.			2,430 lbs.	
<b>EJE</b>		3,170 lbs.			2,860 lbs.			2,700 lbs.			2,600 lbs.	

Boom Length (ft.)	Boom Length 91 ft. (D)			Boom Length 103 ft. (E)			Boom Length 116 ft. (F)			Boom Length 128 ft. (G)		
		CODE 1 Over Rear (lbs.)	CODE 3 Full 360° (lbs.)		CODE 1 Over Rear (lbs.)	CODE 3 Full 360° (lbs.)		CODE 1 Over Rear (lbs.)	CODE 3 Full 360° (lbs.)		CODE 1 Over Rear (lbs.)	CODE 3 Full 360° (lbs.)
15	79	30,000	30,000									
20	76	26,010	26,010	78.5	22,790	22,790						
25	72.5	22,620	22,620	75.5	20,160	20,160	78	17,660	17,660			
30	69.5	20,000	20,000	72.5	18,080	18,080	75.5	16,060	16,060	77.5	13,000	13,000
35	66	17,710	17,710	70.5	16,070	16,070	73	14,480	14,480	75.5	12,760	12,760
40	62.5	15,740	15,740	67.5	14,360	14,360	70.5	13,050	13,050	73	11,760	11,760
45	59	14,050	14,050	64	12,900	12,900	68	11,780	11,780	71	10,800	10,800
50	55	12,620	12,620	60.5	11,610	11,610	65	10,640	10,640	68.5	10,000	10,000
55	50.5	11,380	10,830	57	10,500	10,500	62	9,890	9,890	66	9,130	9,130
60	46.5	10,340	9,160	53.5	9,760	9,290	59	8,970	8,970	63.5	8,320	8,320
65	41.5	9,630	7,800	50	8,860	7,930	56	8,160	8,030	60.5	7,570	7,570
70	36.5	8,770	6,660	46	8,060	6,790	53	7,430	6,900	58	6,910	6,910
75	30	8,000	5,700	41.5	7,350	5,840	49.5	6,780	5,940	55	6,300	6,010
80	22	7,320	4,880	37	6,720	5,020	46	6,180	5,130	52	5,750	5,200
85	7	5,290	4,140	31.5	6,140	4,310	42.5	5,650	4,420	49	5,250	4,490
90				25	5,630	3,690	38	5,160	3,800	46	4,790	3,870
95				15.5	5,160	3,130	33.5	4,720	3,260	42	4,370	3,330
100							28.5	4,310	2,770	38.5	3,980	2,850
105							21.5	3,940	2,330	34	3,620	2,410
110							7.5	3,610	1,920	29.5	3,300	2,020
115										23.5	2,990	1,660
120										15	2,710	1,330
<b>SJ</b>		520 lbs.			460 lbs.			410 lbs.			370 lbs.	
<b>EJR</b>		2,370 lbs.			2,330 lbs.			2,300 lbs.			2,280 lbs.	
<b>EJE</b>		2,520 lbs.			2,460 lbs.			2,410 lbs.			2,380 lbs.	

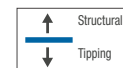

**DEDUCTIONS FROM MAIN BOOM CAPACITIES FOR STOWED JIBS**

SJ = Stowed Jib,  
EJR = Erected Jib Retracted,  
EJE = Erected Jib Extended

**NOTES:**

- Loads based on crane on outriggers
- All "on outriggers" loads are based on 85% tipping
- Loads above heavy line are based on structural rating
- Loads below heavy line are based on tipping rating

Data published herein is intended as a guide only. Crane operation is subject to machine specific load charts and information.

# 50128SHL BOOM DIAGRAM & JIB LOAD CAPACITIES

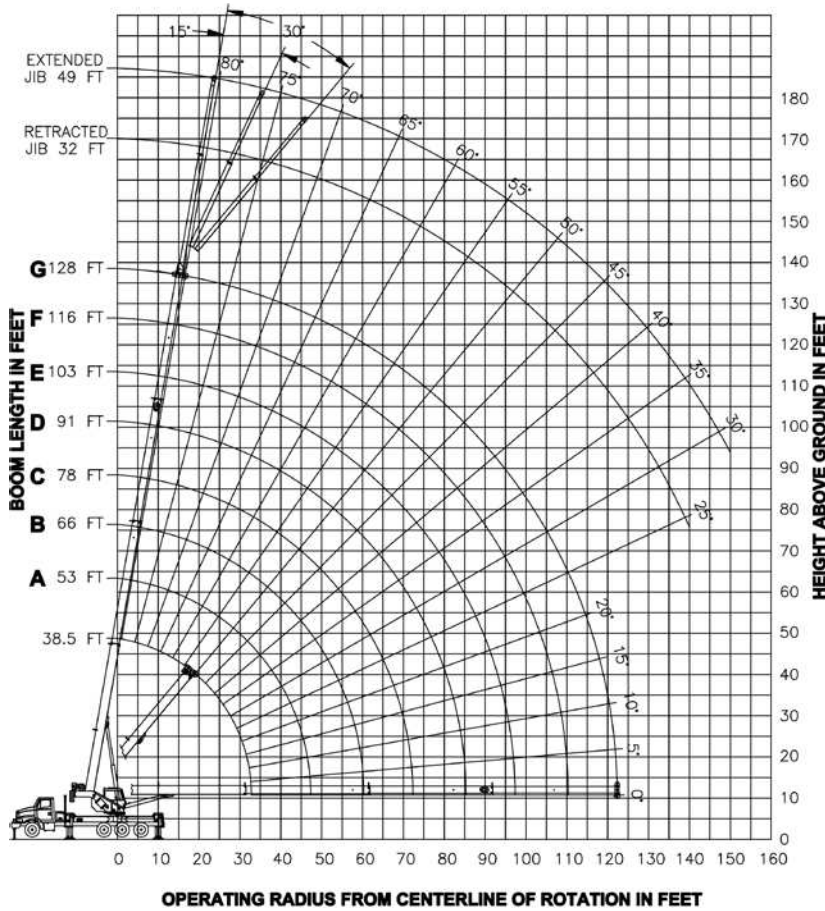

23'-3" (7.07 m) (100%)

23'-3" (7.07 m) (100%)





32 FT. RETRACTED JIB LOAD CAPACITIES								
Boom Length (ft.)	0° Offset		15° Offset		30° Offset			
	Over rear (lbs.)	Full 360° (lbs.)	Over rear (lbs.)	Full 360° (lbs.)	Over rear (lbs.)	Full 360° (lbs.)	Over rear (lbs.)	Full 360° (lbs.)
35	78	5,400	5,400					
40	76.5	5,400	5,400	79.5	5,400	5,400		
45	75	5,400	5,400	78	5,400	5,400		
50	73.5	5,400	5,400	76.5	5,400	5,400	79	5,400
55	72	5,400	5,400	74.5	5,400	5,400	77	5,400
60	70	5,400	5,400	73	5,400	5,400	75	5,400
65	68.5	5,400	5,400	71	5,400	5,400	73	5,240
70	66.5	5,210	5,210	69	5,230	5,230	71.5	4,990
75	64.5	4,740	4,740	67	4,970	4,970	69.5	4,750
80	62.5	4,300	4,300	65	4,570	4,570	67.5	4,520
85	60.5	3,890	3,890	63	4,140	4,140	65	4,310
90	58	3,510	3,510	61	3,740	3,740	63	3,930
95	55.5	3,160	3,150	58.5	3,360	3,360	60.5	3,540
100	53	2,820	2,660	56	3,010	2,960	58	3,170
105	50.5	2,520	2,220	53.5	2,690	2,490	55.5	2,700
110	48	2,230	1,830	50.5	2,390	2,080	52.5	2,250
115	45.5	1,960	1,480	48	2,100	1,700	49.5	1,850
120	42.5	1,700	1,160	45	1,830	1,350	46.5	1,480
125	39.5	1,470	860	42	1,580	1,030	43	1,130
130	36.5	1,240		38.5	1,350		39.5	1,400
135	32.5	1,030		34.5	1,120		35.5	1,160
140	28.5	840		30.5	910		30.5	920

49 FT. EXTENDED JIB LOAD CAPACITIES								
Boom Length (ft.)	0° Offset		15° Offset		30° Offset			
	Over rear (lbs.)	Full 360° (lbs.)	Over rear (lbs.)	Full 360° (lbs.)	Over rear (lbs.)	Full 360° (lbs.)	Over rear (lbs.)	Full 360° (lbs.)
40	78	4,300	4,300					
45	76.5	4,300	4,300					
50	75	4,300	4,300	79.5	4,300	4,300		
55	73.5	4,300	4,300	78	4,300	4,300		
60	72	4,300	4,300	76.5	4,300	4,300	79.5	3,700
65	70.5	4,300	4,300	75	4,300	4,300	78	3,590
70	69	4,300	4,300	73.5	4,230	4,230	76	3,490
75	67.5	4,300	4,300	71.5	4,080	4,080	74	3,390
80	66	4,240	4,240	70	3,930	3,930	72.5	3,300
85	64.5	4,030	4,030	68.5	3,760	3,760	70.5	3,220
90	63	3,740	3,740	66.5	3,590	3,590	69	3,140
95	61	3,430	3,430	64.5	3,420	3,420	67	3,070
100	59	3,120	3,120	62.5	3,270	3,270	65	3,000
105	57	2,840	2,820	60.5	3,100	3,100	63	2,940
110	54.5	2,560	2,420	58	2,810	2,810	61	2,880
115	52	2,310	2,060	56	2,540	2,420	58.5	2,720
120	49.5	2,070	1,740	53.5	2,280	2,070	56	2,320
125	47	1,840	1,440	51	2,040	1,740	53.5	2,190
130	44.5	1,630	1,170	48	1,810	1,440	50.5	1,640
135	42	1,430	920	45.5	1,590	1,160	47.5	1,330
140	39.5	1,240		42.5	1,390	900	44.5	1,480
145	36.5	1,060		39.5	1,190		41	1,260
150	33	900		36	1,000		37	1,050
155				32	820		32.5	850

# 50155S LOAD CHART: Main Boom

Lifting Capacities 5-section Boom 38.5 ft. - 155 ft. Full Outrigger Extension

 23'-3" (7.07 m) (100%)

Boom Length (ft.)	Boom Length 38.5 ft.			Boom Length 63 ft. (A)			Boom Length 74 ft. (B)			Boom Length 86 ft. (C)			Boom Length 97 ft. (D)		
		CODE 1 Over Rear (lbs.)	CODE 3 Full 360° (lbs.)		CODE 1 Over Rear (lbs.)	CODE 3 Full 360° (lbs.)		CODE 1 Over Rear (lbs.)	CODE 3 Full 360° (lbs.)		CODE 1 Over Rear (lbs.)	CODE 3 Full 360° (lbs.)		CODE 1 Over Rear (lbs.)	CODE 3 Full 360° (lbs.)
6	73.5	100,000	100,000												
8	70.5	85,400	85,400												
10	67	75,100	75,100	77	40,000	40,000									
12	64	67,100	67,100	75	40,000	40,000	78	37,700	37,700						
15	58.5	57,700	57,700	72.5	40,000	40,000	75.5	36,340	36,340	78.5	31,000	31,000			
20	49	46,070	46,070	67.5	38,250	38,250	72	33,380	33,380	75	28,200	28,200	77.5	24,120	24,120
25	38	35,280	35,280	62.5	35,040	35,040	67.5	30,620	30,620	71.5	25,970	25,970	74.5	22,200	22,200
30	22.5	27,920	27,490	57	29,140	29,140	63	28,020	28,020	68	23,950	23,950	71	20,480	20,480
35				51.5	23,890	21,500	58.5	24,130	21,830	64	22,080	22,080	68	18,670	18,670
40				45	19,920	16,460	54	20,170	16,770	60.5	20,350	17,010	65	17,210	17,170
45				38	16,810	12,910	48.5	17,060	13,220	56.5	17,250	13,450	61.5	15,920	13,610
50				29.5	14,290	10,280	43	14,570	10,590	52	14,760	10,820	58	14,720	10,970
55				17	12,200	8,210	37	12,510	8,560	47.5	12,710	8,790	54	12,830	8,940
60							29	10,780	6,940	42.5	11,000	7,180	50	11,120	7,320
65							19	9,300	5,600	37	9,540	5,860	46	9,670	6,010
70										30.5	8,280	4,760	41.5	8,420	4,920
75										22.5	7,170	3,830	36.5	7,330	3,990
80										7.5	4,360	2,990	30.5	6,370	3,200
85													23.5	5,520	2,510
90													12	4,140	1,880
<b>SJ</b>	960 lbs.			590 lbs.			500 lbs.			430 lbs.			390 lbs.		
<b>EJ</b>	2,620 lbs.			2,270 lbs.			2,190 lbs.			2,130 lbs.			2,080 lbs.		
	Boom Length 109 ft. (E)			Boom Length 120 ft. (F)			Boom Length 132 ft. (G)			Boom Length 143 ft. (H)			Boom Length 155 ft. (I)		
25	77	18,000	18,000	79	16,260	16,260									
30	74	17,000	17,000	76.5	15,280	15,280	78	13,500	13,500	79.5	11,500	11,500			
35	71.5	15,920	15,920	74	14,270	14,270	76	12,900	12,900	77.5	11,300	11,300	79	9,000	9,000
40	68.5	14,700	14,700	71.5	13,310	13,310	74	12,000	12,000	75.5	11,000	11,000	77	9,000	9,000
45	65.5	13,570	13,570	69	12,410	12,410	71.5	11,300	11,300	73.5	10,460	10,460	75.5	9,000	9,000
50	62.5	12,540	11,100	66	11,600	11,180	69	10,550	10,550	71.5	9,460	9,460	73.5	8,800	8,800
55	59.5	11,580	9,060	63.5	10,840	9,150	67	9,610	9,220	69.5	8,880	8,880	71.5	8,320	8,320
60	56	10,690	7,440	60.5	9,960	7,530	64.5	9,000	7,600	67.5	8,330	7,650	69.5	7,820	7,700
65	53	9,770	6,130	57.5	9,230	6,210	62	8,430	6,280	65	7,800	6,330	67.5	7,340	6,380
70	49	8,530	5,040	54.5	8,550	5,120	59	7,880	5,190	62.5	7,300	5,240	65.5	6,880	5,290
75	45.5	7,440	4,120	51.5	7,520	4,200	56.5	7,390	4,270	60.5	6,820	4,320	63.5	6,410	4,360
80	41.5	6,490	3,330	48	6,570	3,410	53.5	6,630	3,480	58	6,360	3,530	61.5	5,980	3,570
85	37	5,650	2,640	44.5	5,730	2,730	50.5	5,790	2,800	55.5	5,830	2,850	59	5,560	2,890
90	32	4,890	2,040	41	4,980	2,130	47.5	5,040	2,200	52.5	5,090	2,250	57	5,120	2,300
95	25.5	4,210	1,510	36.5	4,300	1,610	44.5	4,370	1,680	50	4,420	1,730	54.5	4,460	1,770
100	17	3,590	1,030	32	3,700	1,140	41	3,770	1,210	47	3,820	1,260	52	3,850	1,310
105				26	3,140		37	3,220		44	3,270	850	49.5	3,310	890
110				19	2,630		33	2,720		40.5	2,770		47	2,810	
115							28	2,250		37	2,310		44	2,360	
120							22	1,830		33	1,890		41	1,940	
125							12	860		28.5	1,500		37.5	1,550	
130										23	1,140		34	1,190	
<b>SJ</b>	340 lbs.			310 lbs.			280 lbs.			260 lbs.			240 lbs.		
<b>EJ</b>	2,050 lbs.			2,020 lbs.			1,990 lbs.			1,970 lbs.			1,950 lbs.		

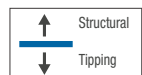

**NOTES:**

- All "on outriggers" loads are based on 85% tipping
- Loads based on crane on outriggers

- Loads above heavy line are based on structural rating
- Loads below heavy line are based on tipping rating

**DEDUCTIONS FROM MAIN BOOM CAPACITIES FOR STOWED JIBS - SJ**  
 = Stowed Jib, EJ= Erected Jib

# 50155S BOOM DIAGRAM & JIB LOAD CAPACITIES

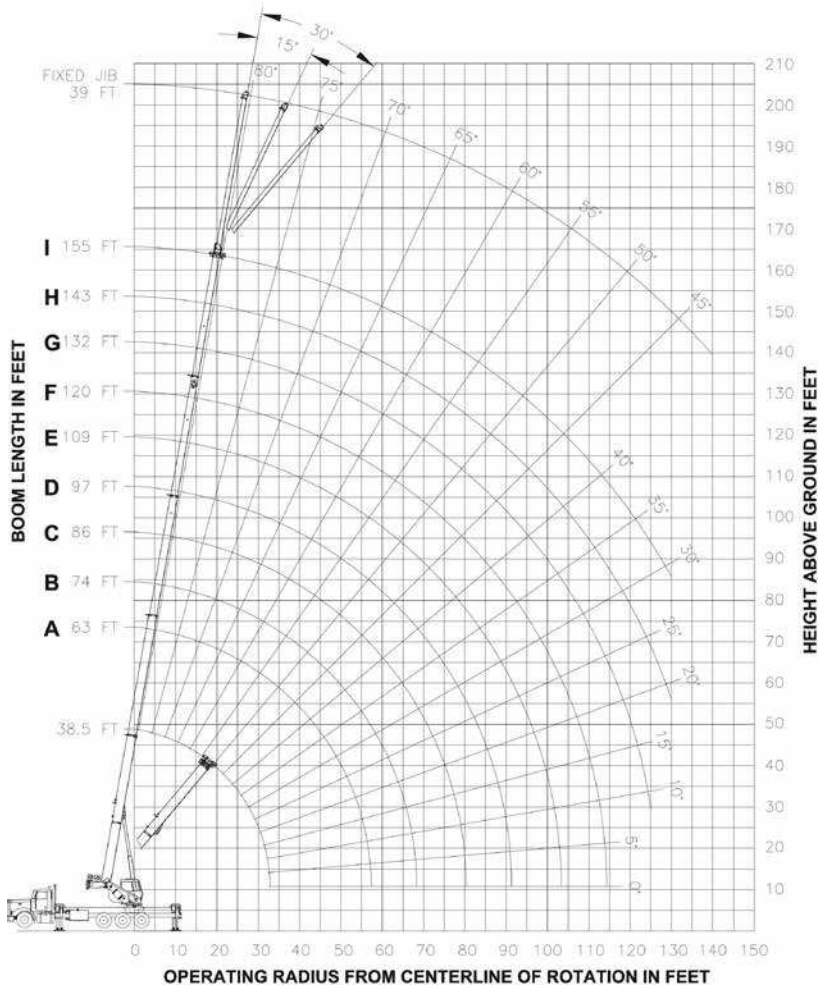







 23'-3" (7.07 m) (100%)

39 FT. FIXED JIB LOAD CAPACITIES								
Boom Length (ft.)	0° Offset		15° Offset			30° Offset		
	Over rear (lbs.)	Full 360° (lbs.)	Over rear (lbs.)	Full 360° (lbs.)	Over rear (lbs.)	Full 360° (lbs.)	Over rear (lbs.)	Full 360° (lbs.)
40	80	4,000	4,000					
45	78	4,000	4,000					
50	77.5	4,000	4,000	80	4,000	4,000		
55	75.5	4,000	4,000	78	4,000	4,000		
60	74	4,000	4,000	76.5	4,000	4,000	80	4,000
65	72.5	4,000	4,000	75	4,000	4,000	78	4,000
70	71	4,000	4,000	73.5	4,000	4,000	76	4,000
75	69.5	4,000	4,000	72	4,000	4,000	74.5	3,880
80	68	4,000	4,000	71	3,940	3,940	73	3,730
85	66.5	3,860	3,360	69.5	3,780	3,780	71.5	3,570
90	65	3,720	2,750	67.5	3,630	3,350	70	3,430
95	63.5	3,430	2,210	66	3,480	2,760	68	3,290
100	61.5	3,150	1,740	64.5	3,340	2,250	66.5	3,160
105	60	2,880	1,310	62.5	3,180	1,780	65	3,030
110	58	2,610	930	61	2,880	1,370	63	2,920
115	56	2,360		59	2,610	990	61	2,800
120	54.5	2,130		57	2,350		59	2,570
125	52.5	1,840		55	2,110		57	2,290
130	50.5	1,490		53	1,830		55	2,040
135	48.5	1,160		51	1,480		53	1,710
140	46	860		48.5	1,150		50.5	1,350
145				46.5	840		48	1,020

# 50155SHL LOAD CHART: Main Boom

Lifting Capacities 5-section Boom 38.5 ft. - 155 ft. Full Outrigger Extension

 23'-3" (7.07 m) (100%)

Boom Length (ft.)	Boom Length 38.5 ft.			Boom Length 63 ft. (A)			Boom Length 74 ft. (B)			Boom Length 86 ft. (C)			Boom Length 97 ft. (D)		
		CODE 1 Over Rear (lbs.)	CODE 3 Full 360° (lbs.)		CODE 1 Over Rear (lbs.)	CODE 3 Full 360° (lbs.)		CODE 1 Over Rear (lbs.)	CODE 3 Full 360° (lbs.)		CODE 1 Over Rear (lbs.)	CODE 3 Full 360° (lbs.)		CODE 1 Over Rear (lbs.)	CODE 3 Full 360° (lbs.)
6	73.5	100,000	100,000												
8	70.5	85,400	85,400												
10	67	75,100	75,100	77	40,000	40,000									
12	64	67,100	67,100	75	40,000	40,000	78	37,700	37,700						
15	58.8	57,700	57,700	72.5	40,000	40,000	75.5	36,340	36,340	78.5	31,000	31,000			
20	49	46,200	46,200	67.5	38,250	38,250	72	33,380	33,380	75	28,200	28,200	77.5	24,120	24,120
25	38	37,290	37,290	62.5	35,040	35,040	67.5	30,620	30,620	71.5	25,970	25,970	74.5	22,200	22,200
30	22.5	28,580	28,580	57	30,700	30,700	63	28,020	28,020	68	23,950	23,950	71	20,480	20,480
35				51.5	25,340	25,140	58.5	25,580	25,470	64	22,080	22,080	68	18,670	18,670
40				45	21,000	19,460	54	21,440	19,780	60.5	20,370	20,010	65	17,210	17,170
45				38	17,940	15,470	48.5	18,200	15,780	56.5	18,380	16,010	61.5	15,920	15,920
50				29.5	15,320	12,500	43	15,590	12,820	52	15,780	13,040	58	14,720	13,190
55				17	12,420	10,180	37	13,440	10,530	47.5	13,640	10,760	54	13,620	10,900
60							29	11,640	8,700	42.5	11,850	8,940	50	11,980	9,090
65							19	10,030	7,200	37	10,330	7,460	46	10,460	7,610
70										30.5	9,010	6,220	41.5	9,150	6,380
75										22.5	7,860	5,170	36.5	8,020	5,340
80										7.5	4,360	4,230	30.5	7,020	4,450
85													23.5	6,120	3,670
90													12	4,140	2,970
<b>SJ</b>	960 lbs.			590 lbs.			500 lbs.			430 lbs.			390 lbs.		
<b>EJ</b>	2,620 lbs.			2,270 lbs.			2,190 lbs.			2,130 lbs.			2,080 lbs.		
	Boom Length 109 ft. (E)			Boom Length 120 ft. (F)			Boom Length 132 ft. (G)			Boom Length 143 ft. (H)			Boom Length 155 ft. (I)		
25	77	18,000	18,000	79	16,260	16,260									
30	74	17,000	17,000	76.5	15,280	15,280	78	13,500	13,500	79.5	11,500	11,500			
35	71.5	15,920	15,920	74	14,270	14,270	76	12,900	12,900	77.5	11,300	11,300	79	9,000	9,000
40	68.5	14,700	14,700	71.5	13,310	13,310	74	12,000	12,000	75.5	11,000	11,000	77	9,000	9,000
45	65.5	13,570	13,570	69	12,410	12,410	71.5	11,300	11,300	73.5	10,460	10,460	75.5	9,000	9,000
50	62.5	12,540	12,540	66	11,600	11,600	69	10,550	10,550	71.5	9,460	9,460	73.5	8,800	8,800
55	59.5	11,580	11,020	63.5	10,840	10,840	67	9,610	9,610	69.5	8,880	8,880	71.5	8,320	8,320
60	56	10,690	9,210	60.5	9,960	9,290	64.5	9,000	9,000	67.5	8,330	8,330	69.5	7,820	7,820
65	53	9,870	7,730	57.5	9,230	7,810	62	8,430	7,880	65	7,800	7,800	67.5	7,340	7,340
70	49	9,150	6,500	54.5	8,550	6,580	59	7,880	6,650	62.5	7,300	6,700	65.5	6,880	6,750
75	45.5	8,130	5,460	51.5	7,930	5,540	56.5	7,390	5,610	60.5	6,820	5,660	63.5	6,410	5,710
80	41.5	7,130	4,570	48	7,210	4,660	53.5	6,880	4,730	58	6,360	4,780	61.5	5,980	4,820
85	37	6,250	3,800	44.5	6,330	3,890	50.5	6,360	3,960	55.5	5,940	4,010	59	5,560	4,050
90	32	5,470	3,130	41	5,550	3,220	47.5	5,620	3,290	52.5	5,540	3,340	57	5,170	3,380
95	25.5	4,750	2,530	36.5	4,850	2,630	44.5	4,920	2,700	50	4,960	2,750	54.5	4,780	2,790
100	17	3,830	1,990	32	4,210	2,100	41	4,280	2,180	47	4,330	2,230	52	4,370	2,270
105				26	3,630	1,620	37	3,710	1,710	44	3,760	1,760	49.5	3,800	1,800
110				19	3,030	1,190	33	3,190	1,280	40.5	3,240	1,340	47	3,280	1,380
115							28	2,700	900	37	2,760	950	44	2,800	1,000
120							22	2,260		33	2,320		41	2,370	
125							12	860		28.5	1,910		37.5	1,960	
130										23	1,530		34	1,590	
135										14.5	1,170		29.5	1,240	
<b>SJ</b>	340 lbs.			310 lbs.			280 lbs.			260 lbs.			240 lbs.		
<b>EJ</b>	2,050 lbs.			2,020 lbs.			1,990 lbs.			1,970 lbs.			1,950 lbs.		

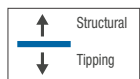



**NOTES:**

- All "on outriggers" loads are based on 85% tipping
- Loads based on crane on outriggers
- Loads above heavy line are based on structural rating
- Loads below heavy line are based on tipping rating

**DEDUCTIONS FROM MAIN BOOM CAPACITIES FOR STOWED JIBS - SJ**  
 = Stowed Jib, EJ= Erected Jib

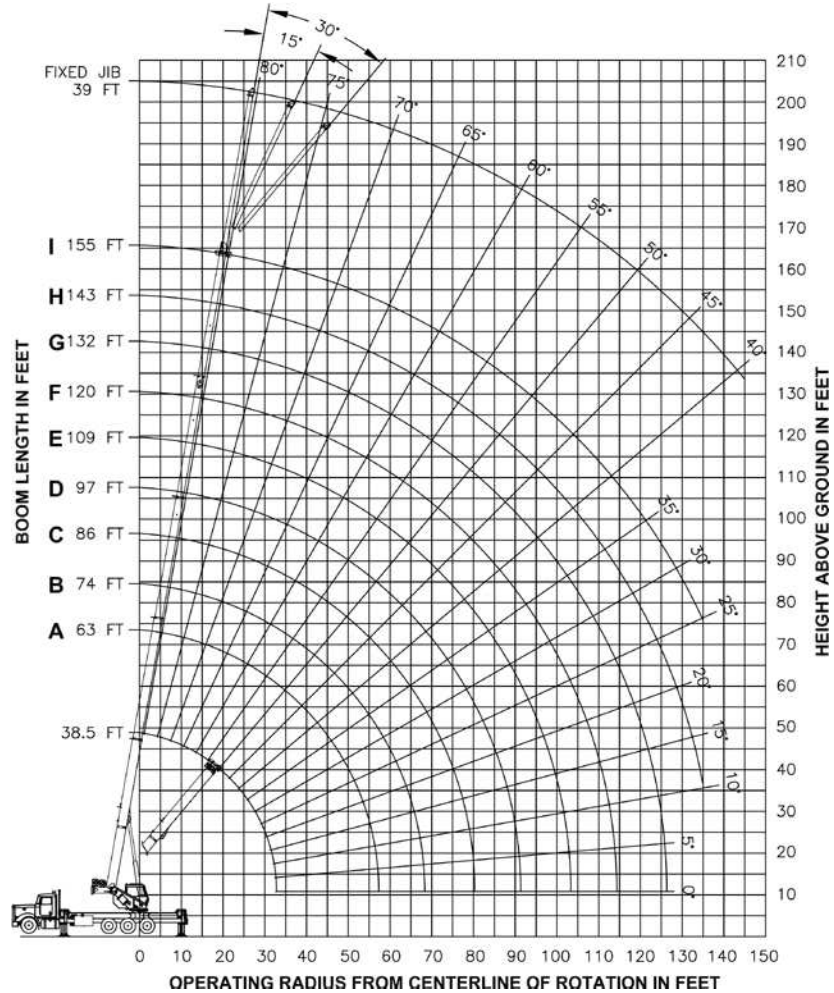
# 50155SHL BOOM DIAGRAM & JIB LOAD CAPACITIES



 23'-3" (7.07 m) (100%)

39 FT. FIXED JIB LOAD CAPACITIES								
Boom Length (ft.)	0° Offset		15° Offset			30° Offset		
	Over rear (lbs.)	Full 360° (lbs.)	Over rear (lbs.)	Full 360° (lbs.)	Over rear (lbs.)	Over rear (lbs.)	Full 360° (lbs.)	
40	80	4,000	4,000					
45	78	4,000	4,000					
50	77.5	4,000	4,000	80	4,000	4,000		
55	75.5	4,000	4,000	78	4,000	4,000		
60	74	4,000	4,000	76.5	4,000	4,000	80	4,000
65	72.5	4,000	4,000	75	4,000	4,000	78	4,000
70	71	4,000	4,000	73.5	4,000	4,000	76	4,000
75	69.5	4,000	4,000	72	4,000	4,000	74.5	3,880
80	68	4,000	4,000	71	3,940	3,940	73	3,730
85	66.5	3,860	3,360	69.5	3,780	3,780	71.5	3,570
90	65	3,720	3,720	67.5	3,630	3,630	70	3,430
95	63.5	3,430	3,240	66	3,480	3,480	68	3,290
100	61.5	3,150	2,700	64.5	3,340	3,210	66.5	3,160
105	60	2,880	2,230	62.5	3,180	2,700	65	3,030
110	58	2,610	1,800	61	2,880	2,230	63	2,920
115	56	2,360	1,410	59	2,610	1,810	61	2,800
120	54.5	2,130	1,060	57	2,350	1,430	59	2,570
125	52.5	1,900		55	2,110	1,080	57	2,290
130	50.5	1,690		53	1,880		55	2,040
135	48.5	1,490		51	1,660		53	1,810
140	46	1,230		48.5	1,460		50.5	1,590
145	43.5	930		46.5	1,200		48	1,380
150				44	890		45.5	1,050

# AREA OF OPERATION

In order to take advantage of full 360° operation, the front bumper stabilizer must be set in accordance to the manual before working in this area.

If a front bumper stabilizer was not supplied, then the front tires must be in contact with the ground before working in this area.

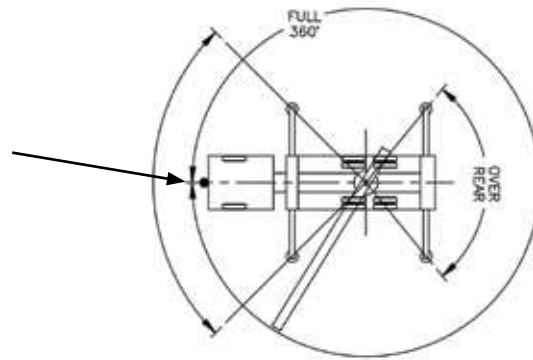

## Deductions from rated loads for load handling devices supplied by Manitex

Auxiliary block	50 lbs. (22.7 kg)
Overhaul ball	See overhaul ball mfr. nameplate
Load blocks	See load block mfr. nameplate
Hose reel	260 lbs. (117.9 kg)
Swing around jib (stowed)	See load chart

**WARNING:** Lifting off the main boom point while the jib is erected is not intended nor approved.

# LMI OPERATING CODES

Code	Crane Configuration	Outrigger Configuration	Area of Operation
#3	Main Boom	Fully Extended	Full 360°
#5	Main Boom	Fully Retracted	Full 360°
#8	Retracted Jib 0° Offset	Fully Extended	Full 360°
#10	Retracted Jib 15° Offset	Fully Extended	Full 360°
#12	Retracted Jib 30° Offset	Fully Extended	Full 360°

# REEVING DIAGRAM

ALLOWABLE LINE PULL										<b>WARNING</b>
1 PART LINE	2 PART LINE	3 PART LINE	4 PART LINE	5 PART LINE	6 PART LINE	7 PART LINE	8 PART LINE	9 PART LINE	10 PART LINE	
										<p>ANTI-TWO-BLOCK SYSTEM MUST BE IN GOOD OPERATING CONDITION BEFORE OPERATING CRANE.</p> <p>REFER TO THE OWNER'S MANUAL.</p> <p>KEEP AT LEAST 3 WRAPS OF LOAD LINE ON THE DRUM AT ALL TIMES.</p>
10000 LBS	20000 LBS	30000 LBS	40000 LBS	50000 LBS	60000 LBS	70000 LBS	80000 LBS	90000 LBS	100000 LBS	



# TECHNICAL DESCRIPTIONS

## Boom



Boom lengths: Proportional boom

- 4-section 96 ft. (29 m)
- 4-section 110 ft. (33,5 m)
- 4-section 128 ft. (39 m)
- 5-section 155 ft. (47 m)

5-sheave quick reeve boom point

Self lubricating slider pads



Boom max. tip height 5096: 153.3 ft. (50,9 m)

Boom max. tip height 50110: 167.1 ft. (51,2 m)

Boom max. tip height 50128: 184.8 ft. (56,3 m)

Boom max. tip height 50155: 202.4 ft. (61,7 m)



Boom angle (min/max): -6° / 80°

## Rotation



Ball-bearing swing circle with external gear  
Double-reduction planetary gearbox driven by hydraulic motor



Slewing brake: Spring-applied pressure released automatic brake  
Free Swing to No-Free Swing Switch



Slewing speed: 1.5 - 2 rpm. (nominal)  
Boom rotation: 360° continuous

## Outriggers



Outriggers: Out-and-down style  
Outrigger monitoring system (for verification only)  
Outrigger motion alarm

Full extension

- Front and rear: 23.3 ft. (7,1 m)

Middle extension

- Front and rear: 15.4 ft. (4,7 m)

Full retraction

- Front and rear: 7.3 ft. (2,2 m)



ROC Solid - Radio operated handheld controller for outrigger, winches and FBS setup

## Operator aids



Wired LMI with crane function cut-offs for overload protection, wired anti-two block system, graphical display, event recorder, WADS - Work Area Definition System

## Hoist, Rope and Hook



Maximum theoretical line speed:  
453 fpm (138 mpm)



Maximum theoretical bottom-layer line pull:  
13,050 lbs. (5,919 kg)



Main winch cable diameter: 5/8 in.  
(15,9 mm) rotation resistant



Line length: 5096S & 50110S - 400 ft. (122 m)  
Line length: 50128 & 50155 - 500 ft. (152 m)



Main winch: Bent axis 2-speed hydraulic motor  
(activated electrically)



Hook and Ball: 5T (4.5 mt) capacity hook with heavy-duty swivel and weight is provided for single line operation.

## Hydraulics



8-bolt direct mounted PTO and SAE C output  
(factory mounted units only)

3-section vane pump, SAE C input

Hydraulic reservoir capacity: 115 gal. (435 L) - 155 gal (587 L)

Pump sections @ 2000 rpm with 100 psi

- Shaft end pump: 41.67 gpm (158 lpm)
- Center pump: 28.3 gpm (107 lpm)
- Cover end pump: 11.7 gpm (44 lpm)

## Tilttable Cab/Cab Controls



Standard features:

Curved glass, 0° to 20° cab tilt, Sliding door, heated cloth seat, 8 seat adjustments, lumbar support, reclining and adjustable head rest, sliding windows, rear pop out window, top hinged hatch, standard diesel fired heater, retractable sun screen, 12 volt DC outlet, E-coated cab (10 year rust warranty)



Controls:

PLC crane controller, CANBUS communication, J1939 truck engine communication capability, electronic hand and foot throttle, Hirschmann/PAT iScout D3 LMI system

# OPTIONS

## Boom

### Max. Boom Length



- 5096S
  - Max boom length with extension: 144.5 ft. (44 m)
- 50110S & 50110SHL
  - Max boom length with extension: 159 ft. (48,5m)
- 50128S & 50128SHL
  - Max boom length with extension: 177 ft. (53,9m)
- 50155S & 50155SHL
  - Max boom length with extension: 194 ft. (59,1m)



- 5096S
  - Max boom length with extension retracted: 127.5 ft. (38,9m)
- 50110S & 50110SHL
  - Max boom length with extension retracted: 142 ft. (43,2m)
- 50128S & 50128SHL
  - Max boom length with extension retracted: 160 ft. (48,8m)
- 50155S & 50155SHL
  - Max boom length with extension retracted: 155 ft. (47,2)

## Bulkhead

24 in. (607 mm) bulkhead

## Hoist, Rope and Hook

- Rooster sheave
- Wireline options available
- 2nd overhaul ball available
- 3rd wrap limiter main and auxiliary winch



Auxiliary lower sheave block for 2-9 part lines  
Load blocks 1-7, 4-8, 2-8, 9-10 part lines

## Boom

### Max. Tip Height



- 5096S
  - Max. tip height: 105.2 ft. (32,1 m)
- 50110S & 50110SHL
  - Max. tip height: 119 ft. (36,3 m)
- 50128 S & 50128SHL
  - Max tip height: 131.9 ft. (40,2 m)
- 50155S & 50155SHL
  - Max. tip height: 163.4 ft. (49,8 m)

### Jibs

- 5096S, 50110S, 50128S
  - 2-section telescopic jib: 32 ft. (9,7 m) to 49 ft. (14,9 m)
- 50155S
  - 1-section fixed jib: 39 ft. (11,8 m)

### Max. Tip Height with Extension



- 5096S
  - Max tip height with extension: 153.3 ft. (46,7 m)
  - Max tip height with extension retracted: 136.5 ft. (41,6 m)
- 50110SS & 50110SSHLL
  - Max tip height with extension: 167.1 ft. (50,9 m)
  - Max tip height with extension retracted: 150.3 ft. (45,8 m)
- 50128S & 50128SHL
  - Max tip height with extension: 184.8 ft. (56,3 m)
  - Max tip height with extension retracted: 168.0 ft. (51,2 m)
- 50155S & 50155SHL
  - Max tip height w/ext = 202.4 ft. (61,7 m)
  - Max tip height w/ ext retracted: No telescopic jib for 50155

## Hydraulics



Hose reel – boom mounted.  
Front Bumper Stabilizer (FBS)

# OPTIONS

# NOTES

## Cab



- Air conditioner
- Engine monitoring system
- Video camera (1 or 2)
- Cab weather band radio system
- Wireless wind speed indicator
- Work lights

## Operator Aids



- 4-function radio remote crane control system either with paddles or joy sticks
  - 900 Mhz
  - 433 Mhz

## 2-person Basket



- Consult Manitex for specific application and rating
  - 2-person gravity level basket
  - 2-person rotating steel basket
  - 2-person quick attach rotating basket

## Tool Boxes & Platforms

### Tool Boxes

- 24 " L x 18" w x 18" H - Steel (610 mm L x 457 mm W x 457 mm H)
- 48 " L X 24" W x 24" H - Aluminum (1219 mm L x 610 mm W x 610 mm H)
- 48 " L X 24" W x 24" H - Aluminum Top MTD-Swing Door (1219 mm L x 610 mm W x 610 mm H)

### Platforms

- Wide Platform Option 102"

---

---

---

---

---

---

---

---

---

---

---

---

---

---

---

---

---

---

---

---

---

---

---

---

---

**Manitex**



# TC500

**50-ton (45 mt) TELESCOPIC CRANE**  
TC500 SERIES PRODUCT GUIDE

**UPTIME**

UPTIME is the Manitex commitment to complete support of thousands of units working every day.

**MANITEX**

3000 South Austin Avenue  
Georgetown, Texas 78626

1-877-314-3390 | [www.Manitex.com](http://www.Manitex.com)

MTX-TC500-PC-EN-V2-0614

Courtesy of Crane.Market