



**RT 555**

**55 US<sup>t</sup> Lifting Capacity  
Rough Terrain Crane  
Datasheet  
Imperial**



# RT 555

**Features:**

- ▶ Rated capacity:  
55 US<sup>t</sup> @ 10 ft working radius
- ▶ Maximum boom length:  
110 ft
- ▶ Maximum tip height:  
170 ft

**WORKS FOR YOU.™**

## Key

.....	3
-------	---

## Dimensions













Crane dimensions .....	4
Crane weights .....	5

## Load charts

Range Diagram – Main Boom – Outriggers fully extended (100%) .....	6
Load Chart – Main Boom – Outriggers fully extended (100%) .....	7
Range Diagram – Main Boom – Outriggers fully retracted (0%) .....	8
Load Chart – Main Boom – Outriggers fully retracted (0%) .....	9
Range Diagram – Main Boom – 33 ft offsettable jib .....	10
Load Chart – Main Boom – 33 ft offsettable jib .....	11
Range Diagram – Main Boom – 57 ft offsettable jib .....	12
Load Chart – Main Boom – 57 ft offsettable jib .....	13
Range Diagram – Main Boom – On tires .....	14
Load Chart – Main Boom – On tires .....	15

## Technical description

Boom .....	16
Hoist, rope and hook .....	16, 17
Superstructure .....	17
Cab, controls, operator aids and load limiter / load indicator .....	17, 18
Carrier, engine, drive-line and hydraulic system .....	18
Vehicle performance .....	19
Tires .....	19

	Counterweight		General performance
	Main boom		Telescoping mode
	Boom length		Boom luffing angle
	Tip height		Working radius
	Boom with extension		Max. boom length with extension
	Main boom with aux head		Distance from the hook to the head sheave pin
	Slewing / Allowable slewing range		Slewing locked / Slewing locked at specified position
	Slewing brake		Slewing gears
	Outriggers / Lifting on outriggers (100/50/0% extended)		Lifting on wheels / Pick & Carry
	Main hoist		Auxiliary hoist
	Hoist speed		Rope length
	Rope - Standard / Optional		Max. line pull
	Rope diameter		Tire
	Hook block		Controls
	Cab		Engine
	Operator aids / Load limiter / Load indicator		Steering
	Mechanical transmission		Speed
	Hydraulics		Heating / Air conditioning
	Working temperature		Gradeability
	Lights		Gross vehicle weight
	Crane / Crane in standard configuration		Weight on front axle
	Crane without counterweight		Weight on rear axle

# CRANE DIMENSIONS

**RT 555**

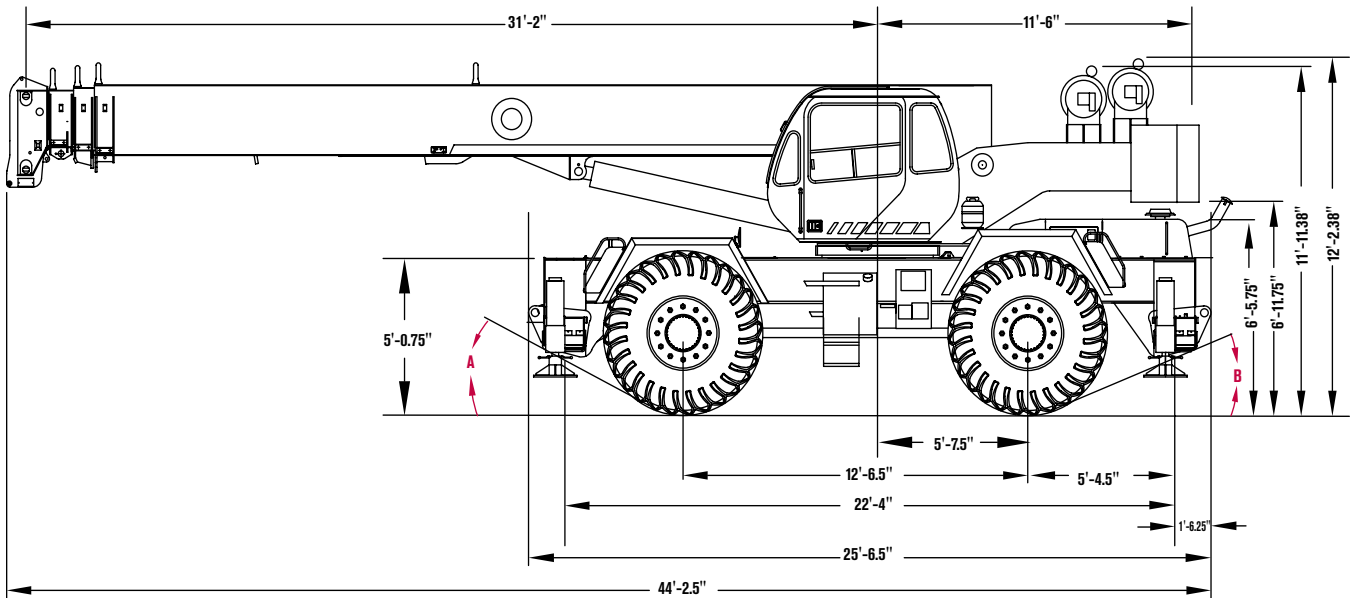

## Notes

- All heights based on 26.5 X 25-26 PR tires
- Add 7" for the tailpipe
- Add 18" for the optional rooster sheave

## Tire Variances



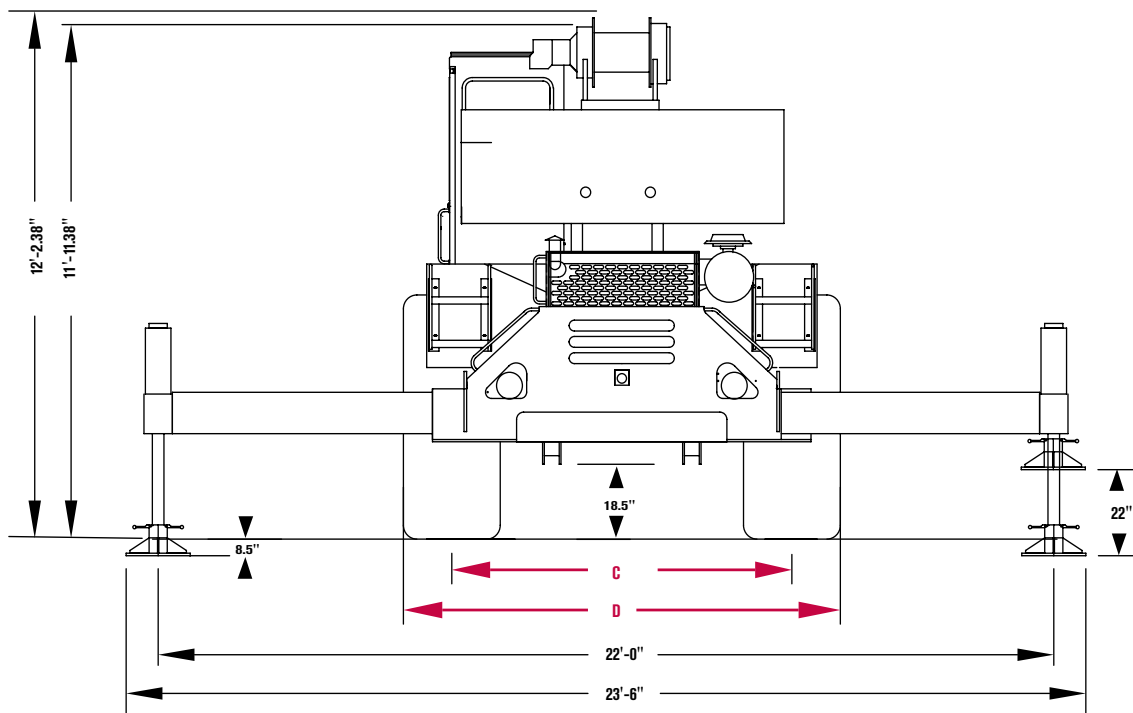



A (Approach Angle)	20°
B (Departure Angle)	25°
C (Tire Track)	8' - 10"
D (Overall Width)	10' - 10"

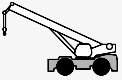

# CRANE WEIGHTS

RT 555

## Approximate Weights

		↓ GVW	↑	↑
	STD (without hook block and auxiliary hoist)	76,832 lb	40,040 lb	36,792 lb
Add / Subtract for main optional equipment				
	33 ft to 57 ft swing on jib stowed	+ 2,160 lb	+ 3,600 lb	- 1,440 lb
	Auxiliary boom head	+ 100 lb	+ 300 lb	- 230 lb
	Auxiliary hoist*	+ 264 lb	+ 60 lb	+ 204 lb
	5 sheaves, 55 USt	+ 723 lb	+ 1,080 lb	- 357 lb
	3 sheaves, 30 USt	+ 240 lb	+ 290 lb	- 50 lb

NOTE: Values are subject to 2% variation

\* Weight includes rope

# RANGE DIAGRAM - MAIN BOOM

RT 555

Outriggers Fully Extended (100%)

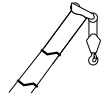

with hook block:  
5 ft 4 in

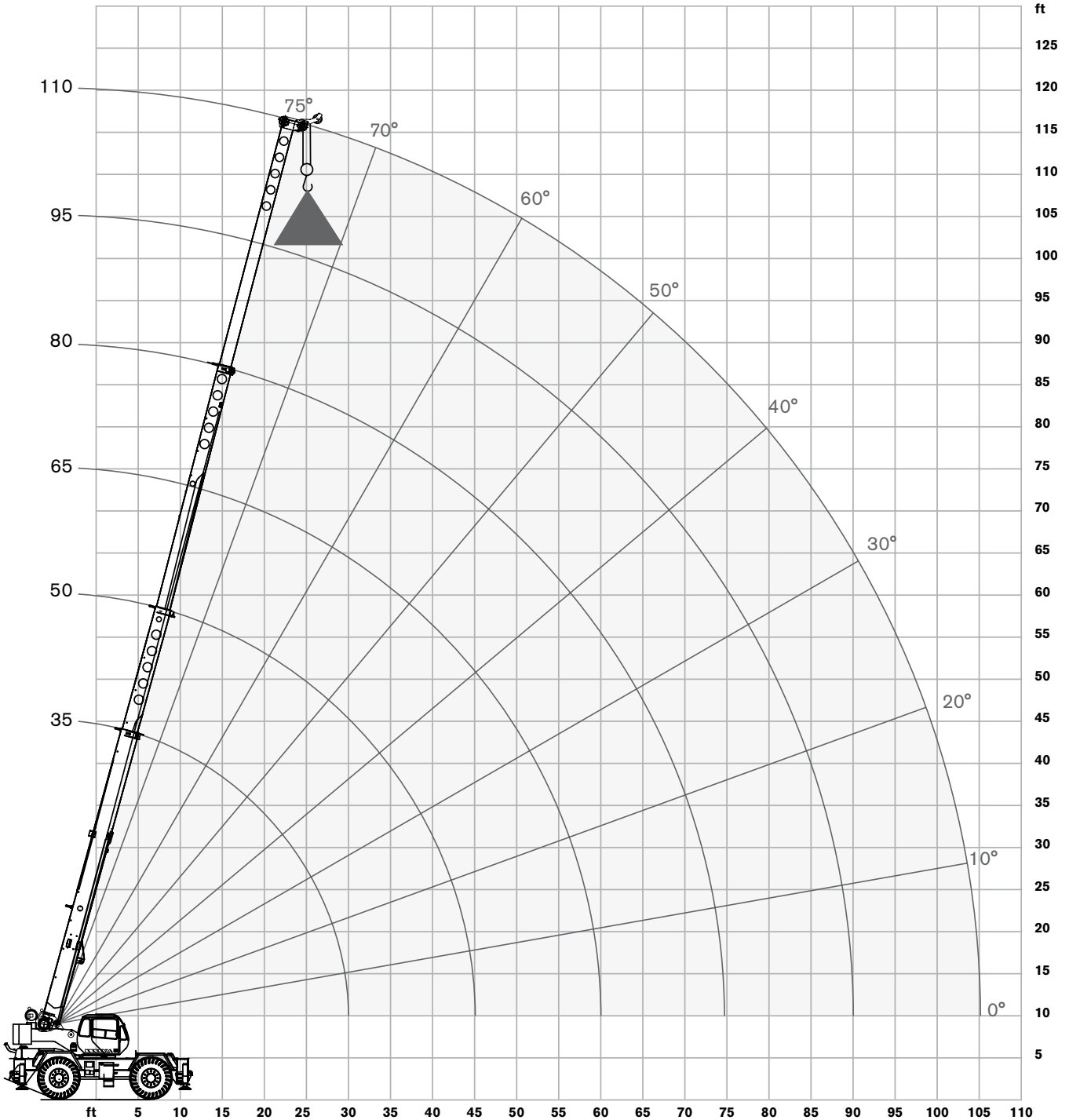



# LOAD CHART- MAIN BOOM

**RT 555**

## Outriggers Fully Extended (100%)

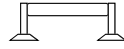
 14,200 lbs counterweight

 Outriggers extended 22 ft (100%)

 360 degree rotation

Standard ASME B30.5

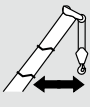
	Boom Length						
	35 ft	50 ft	65 ft	80 ft	95 ft	110 ft	
ft	lb	lb	lb	lb	lb	lb	ft
10	110,000	60,000					10
12	93,600	60,000					12
15	73,000	60,000	58,700				15
20	52,200	53,500	52,100	38,600			20
25	39,600	41,000	41,600	33,500	29,200		25
30	31,100	32,600	33,300	29,500	25,800	22,800	30
35		26,600	27,300	26,400	22,900	20,400	35
40		20,900	21,600	21,900	20,700	18,300	40
45		16,400	17,300	17,600	17,800	16,400	45
50			14,100	14,500	14,700	14,800	50
55			11,600	12,000	12,200	12,300	55
60			9,500	10,000	10,300	10,400	60
65				8,400	8,700	8,800	65
70				7,000	7,300	7,500	70
75				5,800	6,200	6,400	75
80					5,200	5,400	80
85					4,300	4,600	85
90					3,500	3,800	90
95						3,100	95
100						2,500	100
105						2,000	105

### Notes to lifting capacity

Lifting capacities do not exceed 85% of tipping load. Weight of hook blocks and slings is part of the load, and is to be deducted from the capacity ratings. Consult operation manual for further details.

Note: Data published herein is intended as a guide only and shall not be construed to warrant applicability for lifting purposes. Crane operation is subject to the computer charts and operation manual both supplied with the crane.

# RANGE DIAGRAM - MAIN BOOM

RT 555

Outriggers Fully Retracted (0%)



with hook block:  
5 ft 4 in

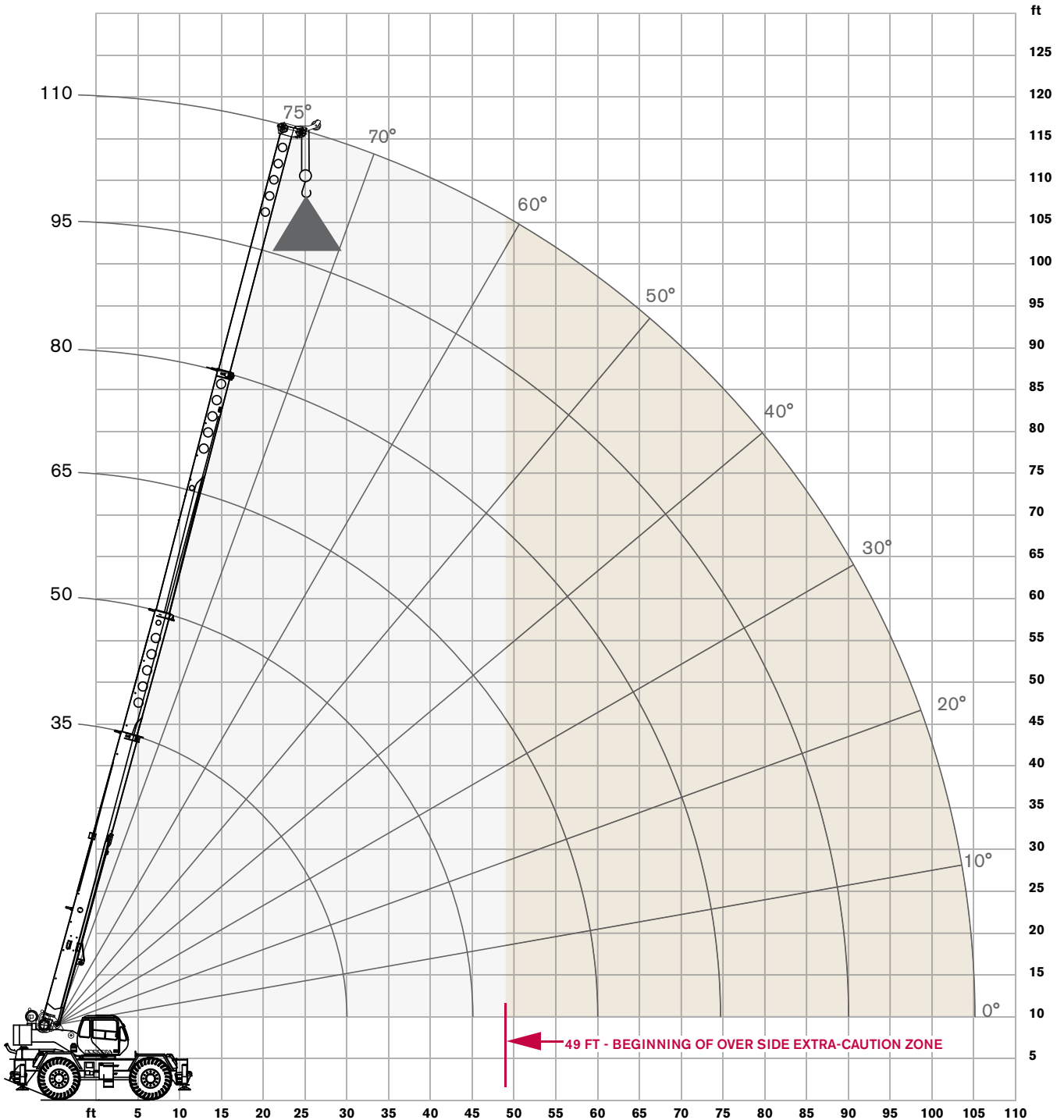





# LOAD CHART- MAIN BOOM

**RT 555**

## Outriggers Fully Retracted (0%)

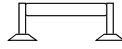
 14,200 lbs counterweight

 Outriggers retracted 9 ft 1 in (0%)

 360 degree rotation

Standard ASME B30.5

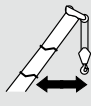
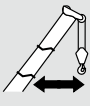
	Boom Length						
	35 ft	50 ft	65 ft	80 ft	95 ft	110 ft	
ft	lb	lb	lb	lb	lb	lb	ft
10	66,900	60,000					10
12	46,700	47,900					12
15	30,800	32,000	32,500				15
20	17,800	19,200	19,600	19,900			20
25	11,100	12,500	13,100	13,300	13,500		25
30	6,900	8,400	9,100	9,400	9,500	9,600	30
35		5,600	6,300	6,700	6,800	7,000	35
40		3,600	4,300	4,700	4,900	5,000	40
45		2,000	2,800	3,200	3,400	3,600	45
50			1,600	2,000	2,300	2,400	50
55					1,300	1,500	55

### Notes to lifting capacity

Lifting capacities do not exceed 85% of tipping load. Weight of hook blocks and slings is part of the load, and is to be deducted from the capacity ratings. Consult operation manual for further details.

Note: Data published herein is intended as a guide only and shall not be construed to warrant applicability for lifting purposes. Crane operation is subject to the computer charts and operation manual both supplied with the crane.

# RANGE DIAGRAM - MAIN BOOM

RT 555

With Jib, 33 ft offset



with hook block:  
5 ft 4 in

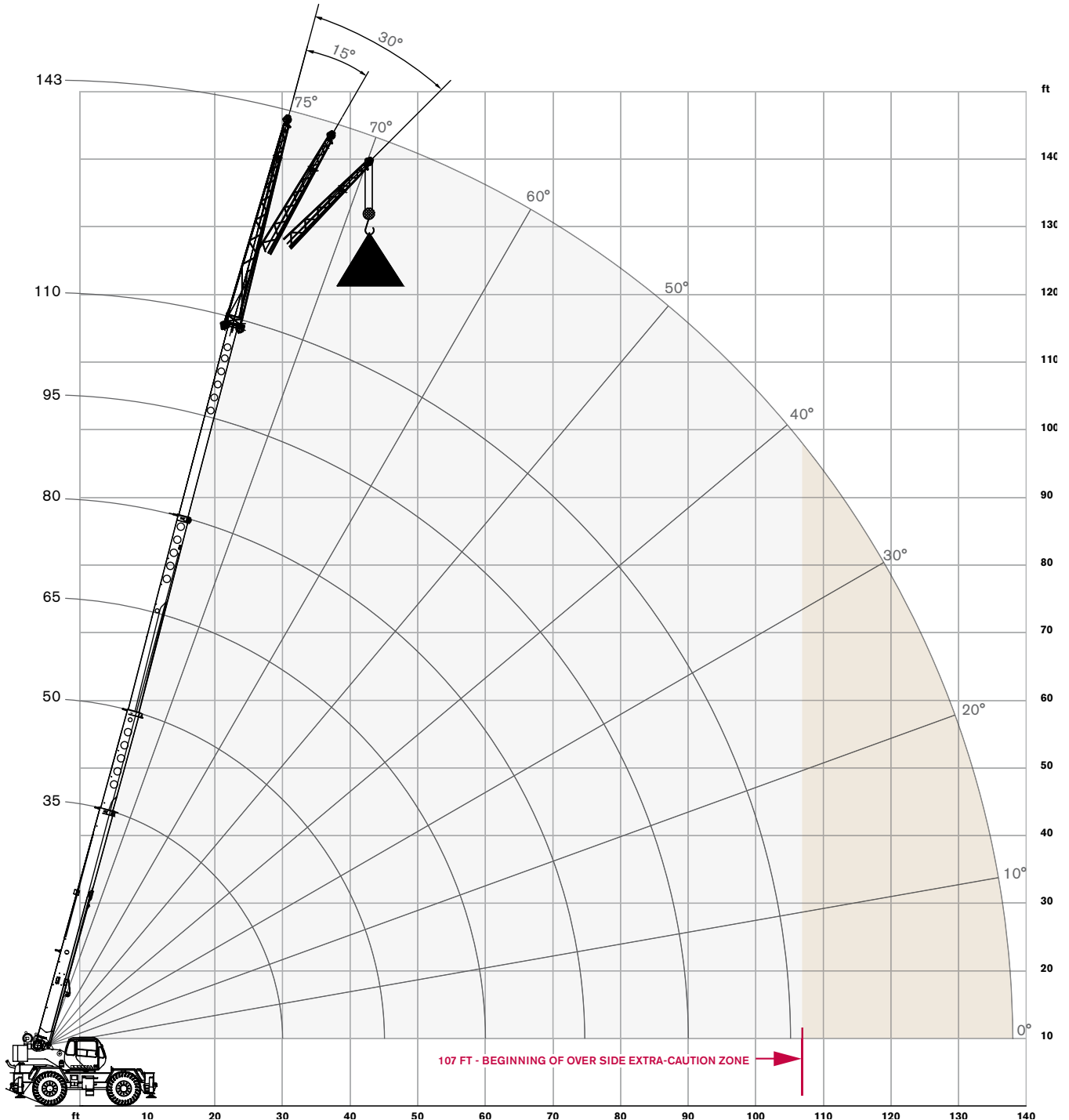



# LOAD CHART- MAIN BOOM

**RT 555**

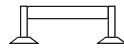

**With Jib, 33 ft offset**

 14,200 lbs counterweight

 Outriggers extended 22 ft (100%)

 360 degree rotation

Standard ASME B30.5

33 ft Offsettable Jib					
0° Offset		15° Offset		30° Offset	
 Radius (ft)	lbs	 Radius (ft)	lbs	 Radius (ft)	lbs
38	12,000	46	8,400	53	6,500
44	11,500	51	8,100	58	6,300
50	11,000	57	7,700	63	6,200
57	10,300	64	7,300	70	5,900
64	8,600	70	7,000	76	5,800
71	7,000	76	6,400	81	5,600
78	6,000	83	5,500	87	5,100
85	4,800	90	4,300	93	3,900
91	3,800	97	3,300	101	3,100
98	2,900	103	2,600	107	2,500
104	2,000	110	2,000	112	2,000
112	1,400	117	1,500	118	1,400
120	900	123	900	125	900

## Notes to lifting capacity

Lifting capacities do not exceed 85% of tipping load. Weight of hook blocks and slings is part of the load, and is to be deducted from the capacity ratings. Consult operation manual for further details.

Note: Data published herein is intended as a guide only and shall not be construed to warrant applicability for lifting purposes. Crane operation is subject to the computer charts and operation manual both supplied with the crane.

# RANGE DIAGRAM - MAIN BOOM

RT 555

With Jib, 57 ft offset

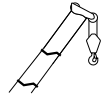

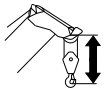
 with hook block:  
5 ft 4 in

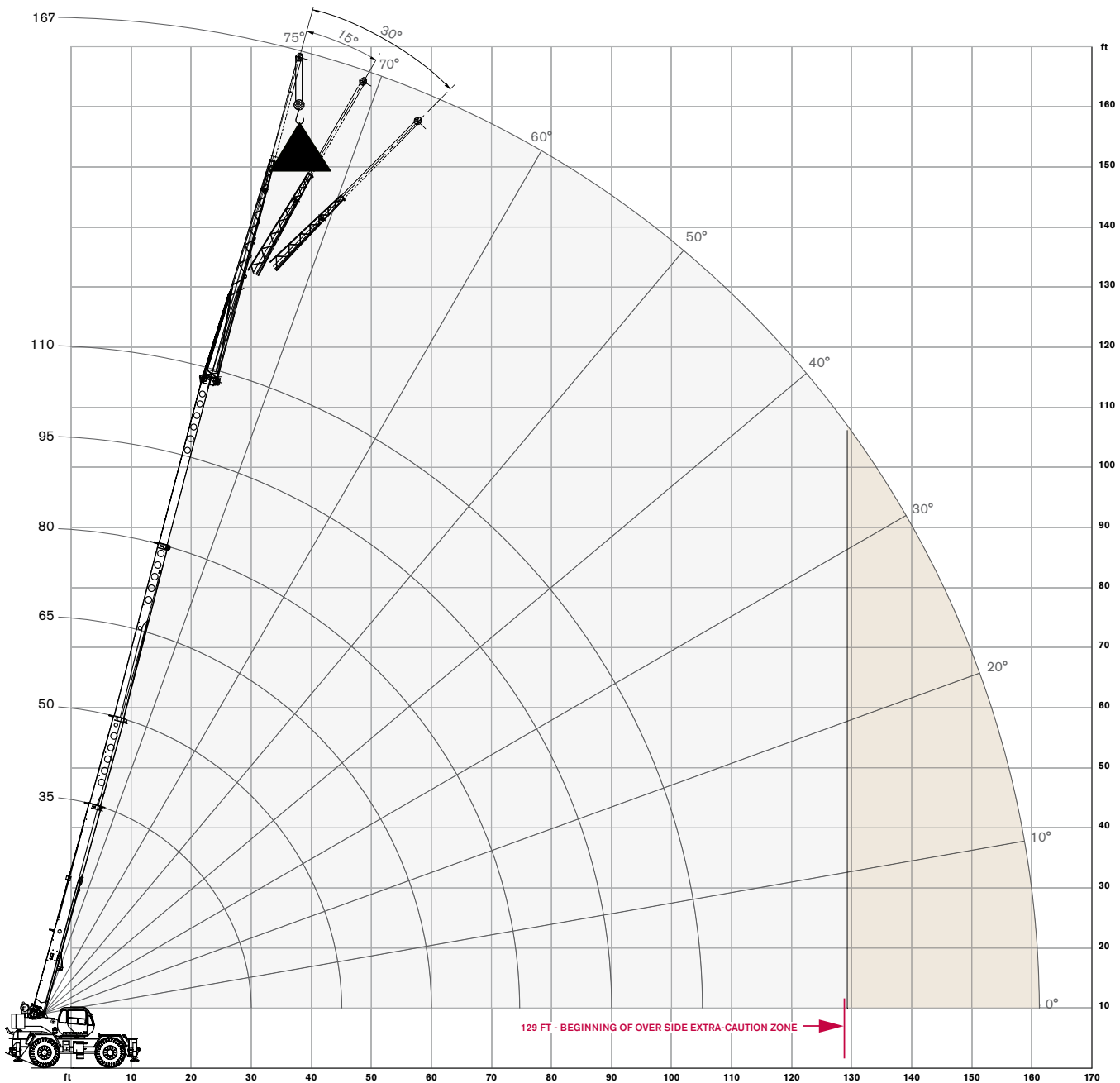



# LOAD CHART- MAIN BOOM

**RT 555**



**With Jib, 57 ft offset**

 14,200 lbs counterweight

 Outriggers extended 22 ft (100%)

 360 degree rotation

Standard ASME B30.5

57 ft Offsettable Jib					
0° Offset		15° Offset		30° Offset	
 Radius (ft)	lbs	 Radius (ft)	lbs	 Radius (ft)	lbs
46	6,000	61	4,500	71	3,300
53	6,000	66	4,300	77	3,200
59	5,800	73	4,100	83	3,100
67	5,500	80	3,800	90	3,000
75	5,100	88	3,600	96	2,900
84	4,700	95	3,400	102	2,800
93	4,400	103	3,300	108	2,700
103	3,600	111	3,100	114	2,600
112	2,700	118	2,500	121	2,400
120	2,100	125	2,000	128	1,900
128	1,600	132	1,500	135	1,400
135	1,100	139	1,000	142	1,000

## Notes to lifting capacity

Lifting capacities do not exceed 85% of tipping load. Weight of hook blocks and slings is part of the load, and is to be deducted from the capacity ratings. Consult operation manual for further details.

Note: Data published herein is intended as a guide only and shall not be construed to warrant applicability for lifting purposes. Crane operation is subject to the computer charts and operation manual both supplied with the crane.

# RANGE DIAGRAM - MAIN BOOM

RT 555

On Tires

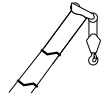

 with hook block:  
5 ft 4 in

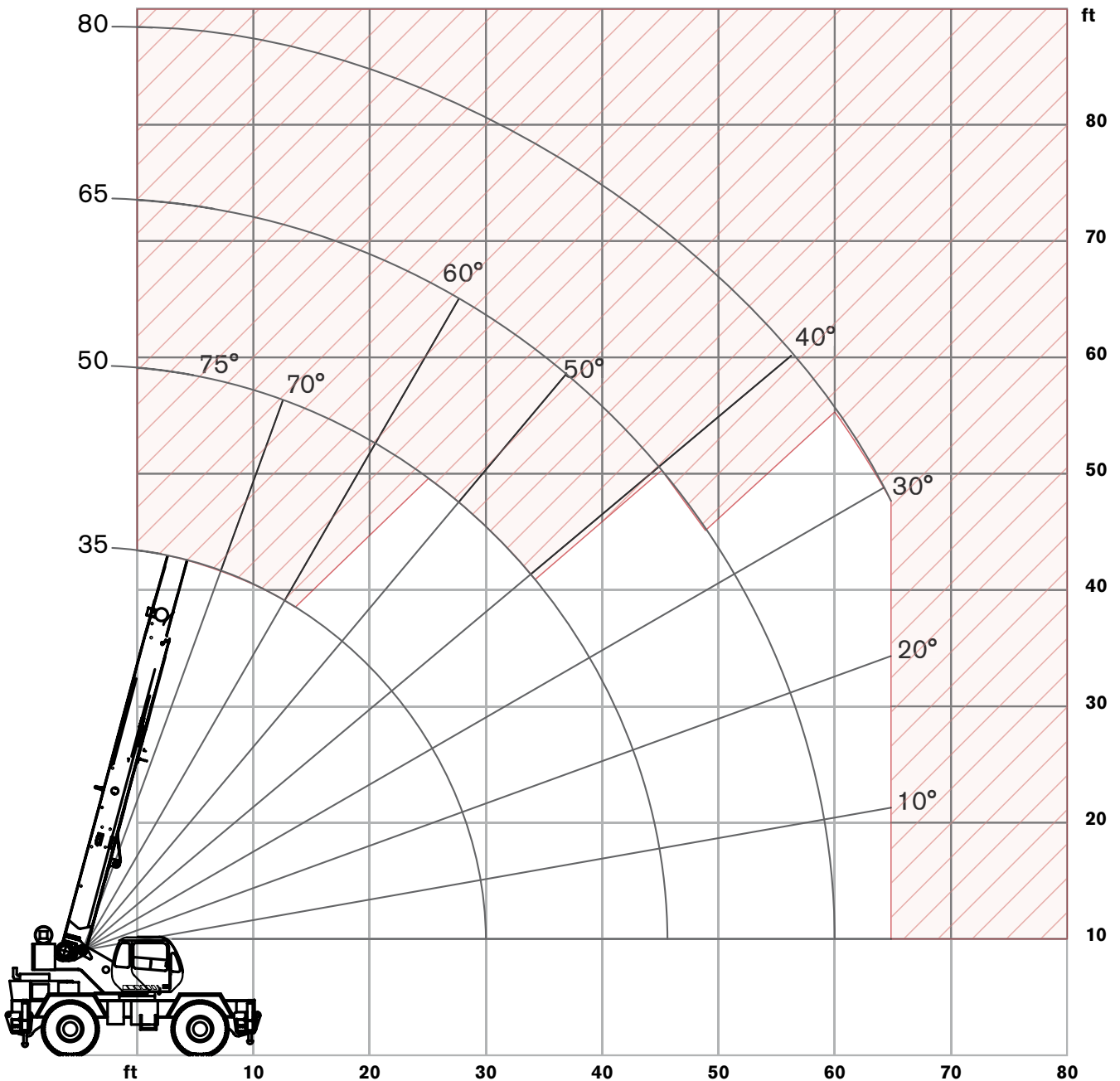



# LOAD CHART- MAIN BOOM

**RT 555**

## On Tires

 14,200 lbs counterweight

 360 degree rotation

 On tires  
26.5 X 25-26 PR

Standard ASME  
B30.5









Boom		Travel Speed Boom straight over front		
Radius	Length	0 mph	Creep	2.5 mph
ft	ft	lb	lb	lb
10	35	65,000	49,200	41,100
12	35	56,500	42,400	35,300
15	35	46,800	34,800	28,700
20	35	31,500	25,900	21,000
25	50	20,700	19,900	15,800
30	50	14,200	14,200	12,000
35	50	10,500	10,500	9,400
40	50	7,900	7,900	7,600
45	65	6,300	6,300	6,200
50	65	5,100	5,100	5,000
55	65	4,100	4,100	4,000
60	80	3,100	3,100	3,100
65	80	2,300	2,300	2,300

## Notes to lifting capacity







Lifting capacities do not exceed 75% of tipping load. Weight of hook blocks and slings is part of the load, and is to be deducted from the capacity ratings. Consult operation manual for further details.

Note: Data published herein is intended as a guide only and shall not be construed to warrant applicability for lifting purposes. Crane operation is subject to the computer charts and operation manual both supplied with the crane.



## Boom

Standard configuration:	
	4 sections hydraulic actuated boom
	Full power mechanically synchronized
	Min. / Max. <span style="float: right;">35 ft / 110 ft</span>
	Boom elevation angle range (min. / max.) <span style="float: right;">-4° / 76°</span>
Optional configuration:	
	Single sheave
	One section, side stowable Angular offsets <span style="float: right;">0, 15 and 30 degrees</span>
	Two sections bi-fold, side stowable Angular offsets <span style="float: right;">0, 15 and 30 degrees</span>
	With one section jib (max.) <span style="float: right;">146 ft</span>
	With two section jib (max.) <span style="float: right;">170 ft</span>

## Hoist, Rope and Hook

Standard configuration:	
	Grooved drum Storage capacity <span style="float: right;">939 ft</span>
	Two speed ratios
	Without load in 5th layer (low range / high range) <span style="float: right;">248 ft/min / 496 ft/min</span> Without load in 1st layer (low range / high range) <span style="float: right;">171 ft/min / 343 ft/min</span>
	6 x 19 IWRC XIPS, right regular lay, preformed
	<span style="float: right;">5/8 in</span>
	<span style="float: right;">500 ft</span>
	Max. line pull; 1st layer low-range <span style="float: right;">15,639 lb</span>
	Max. line pull permissible <span style="float: right;">11,250 lb</span>





Optional configuration:		
	3 sheaves 5 sheaves	30 US t 55 US t
	Grooved drum Storage capacity	939 ft
	Without load in 5th layer (low range / high range) Without load in 1st layer (low range / high range)	248 ft/min / 496 ft/min 171 ft/min / 343 ft/min
	Rotation resistant compacted strand 34X7	
		5/8 in
		500 ft
	Minimum breaking strength Max. line pull permissible	56,420 lbs 11,250 lbs

## Superstructure

Standard configuration:		
	Non stop Maximum rotation speed without load	360° 2 rpm
	Hydraulic motor Planetary reducer	
	Foot actuated pedal - provides variable braking force	
	Travel Lock - 360° house lock	

## Cab, Controls, Operator aids and Load limiter / Load indicator

Standard configuration:		
	Sliding door Hinged, tinted all glass skylight Six way adjustable seat	
	Armrest mounted dual axis electro-proportional joysticks Steering wheel column with gear selector on the left and directional light selector on the right Dashboard mounted switches for outrigger operation	
	Graphic interface for rated capacity indicator	

## Optional configuration:



Hydraulic powered air conditioner  
 Hydraulic powered heater  
 Work lights  
 Rotating beacon

## Carrier, Engine, Drive-line and Hydraulic system

### Standard configuration:



Hydraulic, independent extension:  
 Diameter of outrigger pads  
 Area of outrigger pads

24 in  
 452 in<sup>2</sup>



Tier 4F  
 Cummins QSB6.7 6 cylinders  
 Rated power  
 Maximum gross torque  
 Intake: Turbocharger with intercooler

173 hp @ 2,200 rpm  
 620 ft-lb @ 1,500 rpm

Tier 3  
 Cummins QSB6.7 6 cylinders  
 Rated power  
 Maximum gross torque  
 Intake: Turbocharger with intercooler

173 hp @ 2,200 rpm  
 590 ft-lb @ 1,400 rpm

Fuel type  
 Fuel tank capacity

Diesel  
 80 gallons



6 x 6 powershift transmission with torque converter  
 Selectable 4WD (Four-Wheel Drive)  
 Rigid mounted front axle  
 Oscillating rear axle  
 Rear axle oscillation lock - manual or automatic actuation  
 Air-over-hydraulic disc brakes  
 Front axle parking brake  
 Hydraulic oil cooler



Hydraulic power steering  
 Front wheel steering  
 Four wheel steering concentric  
 Four wheel steering crab



Hydraulic Pumps:  
**Tandem pumps:**  
 Boom lift / Telescope  
 Power steering / Outriggers and swing  
**Single pump:**  
 Main and auxiliary hoist pump

39.1 gal/min @ 3,500 psi  
 19.6 gal/min @ 2,500 psi  
 55.3 gal/min @ 3,500 psi

Hydraulic oil reservoir capacity  
 Hydraulic oil suction filter  
 Hydraulic oil return filter

112 gallons  
 250 microns  
 5 microns

## Vehicle performance

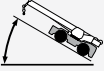
Standard configuration:		
	Max. in 1 <sup>st</sup> gear Max. in 6 <sup>th</sup> gear	>100% 5.6%
	Max. (6 <sup>th</sup> gear)	22.8 mph

## Tires

Standard configuration:		
	Wide tread - Earth mover pattern	26.5 R25

Effective Date: May 2016. Product specifications and prices are subject to change without notice or obligation. The photographs and/or drawings in this document are for illustrative purposes only. Refer to the appropriate Operator's Manual for instructions on the proper use of this equipment. Failure to follow the appropriate Operator's Manual when using our equipment or to otherwise act irresponsibly may result in serious injury or death. The only warranty applicable to our equipment is the standard written warranty applicable to the particular product and sale and Terex makes no other warranty, express or implied. Products and services listed may be trademarks, service marks or trade-names of Terex Corporation and/or its subsidiaries in the USA and other countries. All rights are reserved. Terex® is a registered trademark of Terex Corporation in the USA and many other countries. Copyright 2016 Terex Corporation.

Terex Cranes, Global Marketing, Dingerstraße 24, 66482 Zweibrücken, Germany  
Tel. +49 (0) 6332 830, Email: [info.cranes@terex.com](mailto:info.cranes@terex.com), [www.terexcranes.com](http://www.terexcranes.com)



[www.terexcranes.com](http://www.terexcranes.com)

Brochure Reference: TC-DS-I-E-RT 555-05/16



**WORKS FOR YOU.™**